



SYSKOR

Living Home Group

SYSKOR GROUP

Syskor Sistemas de Perfiles, S.L.
Polígono Industrial Jundiz. Calle Bidegana, 6
01015 · Vitoria-Gasteiz · Álava · SPAIN
T +34 945 466 311 · F +34 945 465 771
syskor@syskor.es
www.syskor.es

a l u m i n i u m s y s t e m s

Sistemas para armarios catálogo 2023



SYSKOR
Living Home Group



Puertas plegables

1



Puertas coplanares

2



Puertas correderas
colgantes superpuestas

3



Puertas correderas
apoyadas

4



Puertas colgantes
de paso

5



Interiorismo
para armarios

6



Estanterías
de aluminio

7



Iluminación leds
para muebles

8

Diseño
Tecnología
Calidad
Distribución
Servicio



the living

SYSKOR

Syskor Group

Con sede en Vitoria-Gasteiz (España) y fundada en el año 2007, **Syskor** es marca líder en el diseño, fabricación y venta de **herrajes y componentes** para la industria del mueble y la cocina.

Ponemos a su disposición la más completa gama de soluciones técnicas en sistemas de aluminio, herrajes de cocina y componentes funcionales dirigidas a la **industria del mueble, almacenes de distribución, ferreterías, ebanistas y bricolaje.**



home group

SYSKOR
Living Home Group



Diseño Syskor

Analizamos constantemente **nuevas tendencias**. Diseñamos y desarrollamos **soluciones técnicas funcionales** que permiten la fabricación de muebles **bonitos, duraderos, prácticos y fiables**.

Tecnología industrial

Tecnología punta de fabricación para herrajes eficientes y de máxima **seguridad y fiabilidad**. Como empresa responsable, producimos respetando las más estrictas **normas medioambientales y sociales**. Cuidamos de las personas y del entorno, **cuidamos de ti**.

Calidad Premium

Buscamos la calidad óptima adecuada tanto a sus **necesidades de distribución y venta** como de montaje y **eficiencia en la fabricación** del mueble y su posterior uso.

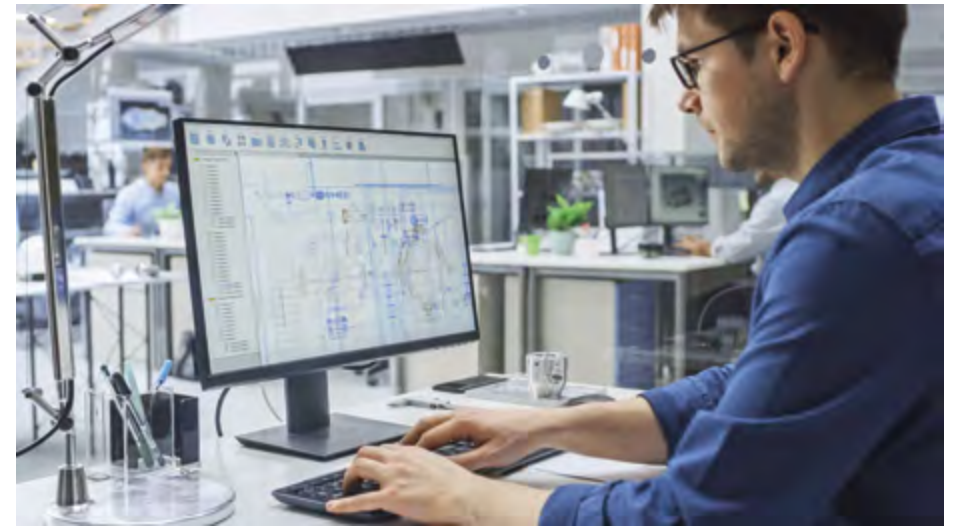

Gama completa

Le ofrecemos un **completo abanico de herrajes funcionales** que permiten la **fabricación de todo tipo de muebles**. Le ofrecemos la **mejor solución para cada necesidad y zona de la casa**.

Distribución y logística integral

Todos nuestros herrajes **disponibles inmediatamente**, 15000 metros cuadrados de modernos almacenes logísticos para una **respuesta rápida y sin fallos**. Tenemos lo que le interesa.

Servicio y atención personal

Satisfacemos sus **necesidades con un trato inmediato y personalizado**. Le apoyamos cada día con vocación y dedicación: **Su negocio es de nuestro interés**.



SYSKOR

aluminium systems



Foto: Armario con puertas plegables-correderas Axis Free - Syskor

Puertas plegables

1

SYSKOR
aluminium systems

axis free 2

Sistema de puertas plegables-correderas
2 puertas (4 hojas)



SYSKOR
kitchen & home fittings

Especificaciones:

- Sistema de puertas plegables-correderas para armarios.
- Cierre amortiguado.
- Peso máximo por puerta (2 hojas): 40 Kg.
- Espesores de puerta: 16-19 mm.
- Anchura de puerta: 600-1200 mm. (300-600 mm por hoja)
- Altura máxima de puerta: 2500 mm.

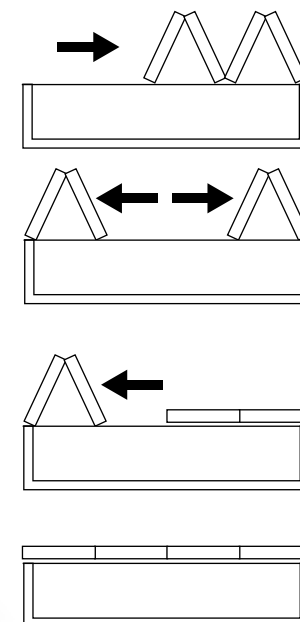

AXIS FREE 2 PUERTAS (4 HOJAS) PLEGABLES-CORREDERAS

cod. **660AXF002**

Kit de carros Axis Free 2:
Kit de carros altos y bajos para un armario de 2 puertas (4 hojas) plegables-correderas con cierre amortiguado

Caja interior autoventa de 1 kit

* Embalaje exterior de 4 kits



KIT CARRIL SUPERIOR Y CARRIL INFERIOR AXIS FREE PLEGABLES-CORREDERAS

| cod. | longitud |
|-----------|-----------------------|
| 660AXF240 | set carriles de 2,4 m |

Caja interior autoventa de 1 kit

* Embalaje exterior de 4 kits

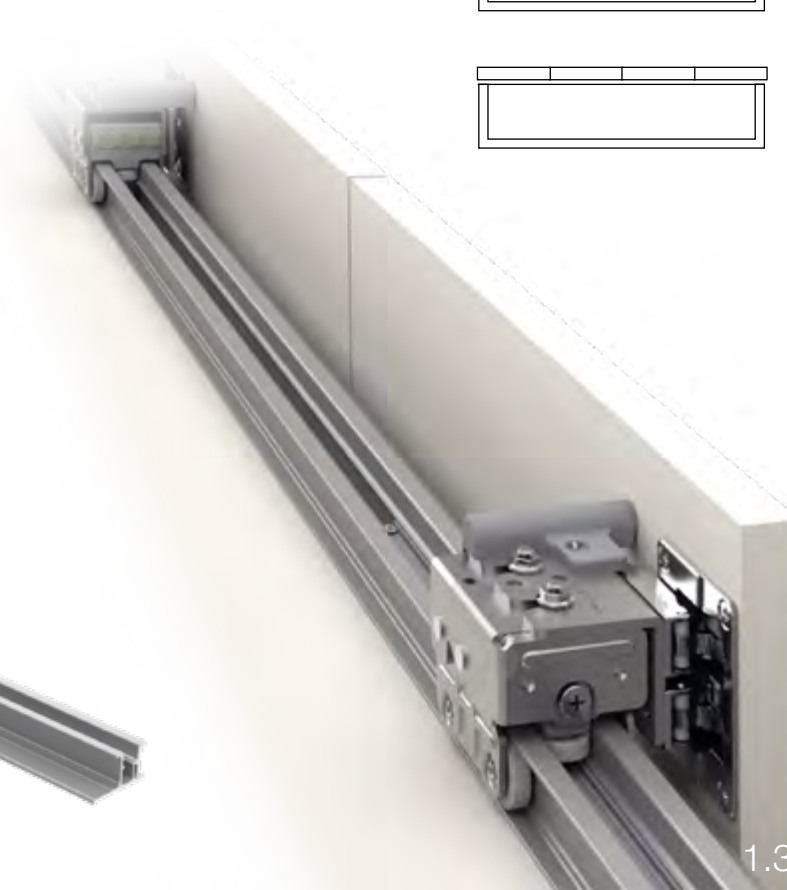
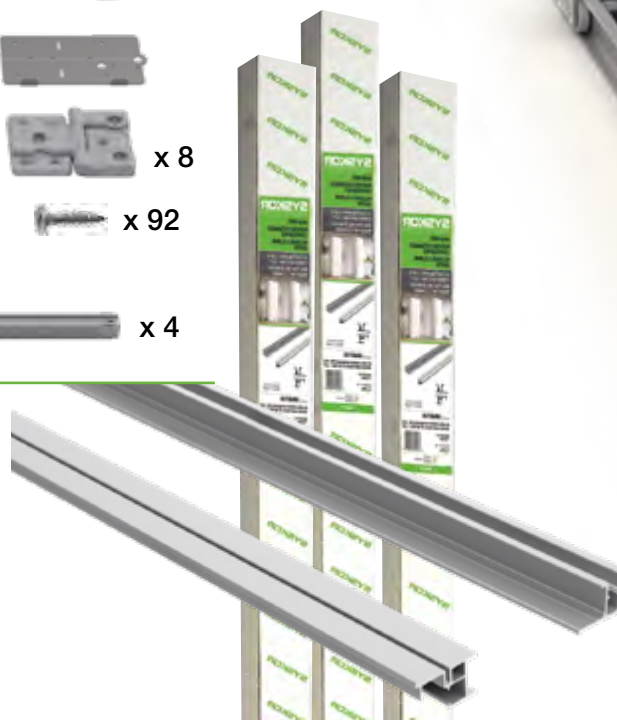
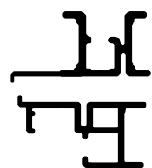

axis free 1

Sistema de puertas plegables-correderas
1 puerta (2 hojas)



SYSKOR
kitchen & home fittings

Especificaciones:

- Sistema de puertas plegables-correderas para armarios.
- Cierre amortiguado.
- Peso máximo por puerta (2 hojas): 40 Kg.
- Espesores de puerta: 16-19 mm.
- Anchura de puerta: 600-1200 mm. (300-600 mm por hoja)
* Para hojas de 300 a 380mm utilice únicamente 2 amortiguadores
- Altura máxima de puerta: 2500 mm.

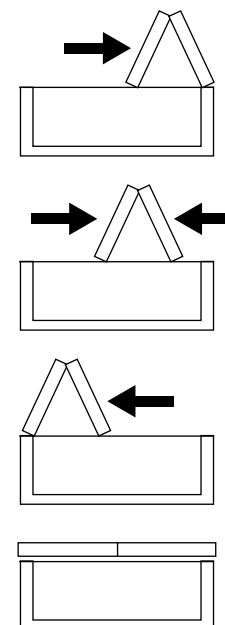

AXIS FREE 1 PUERTA (2 HOJAS) PLEGABLES-CORREDERAS

cod. **660AXF001**

Kit de carros Axis Free 1 :
Kit de carros altos y bajos para un armario de 1 puerta (2 hojas) plegables-correderas con cierre amortiguado

Caja interior autoventa de 1 kit

* Embalaje exterior de 10 kits

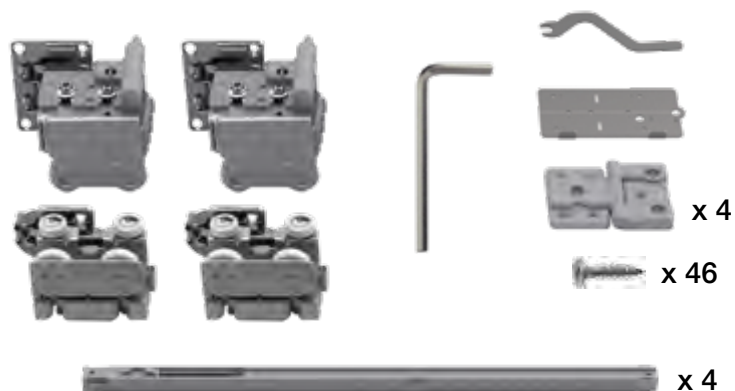

KIT CARRIL SUPERIOR Y CARRIL INFERIOR AXIS FREE PLEGABLES-CORREDERAS

| cod. | longitud |
|-----------|-----------------------|
| 660AXF120 | set carriles de 1,2 m |

Caja interior autoventa de 1 kit

* Embalaje exterior de 4 kits

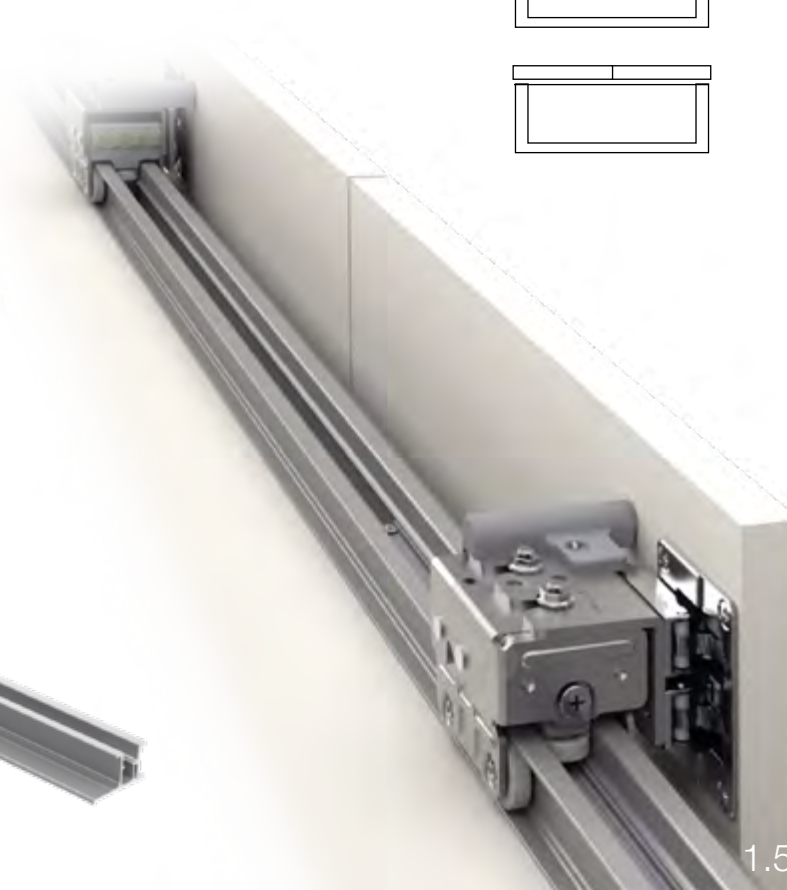
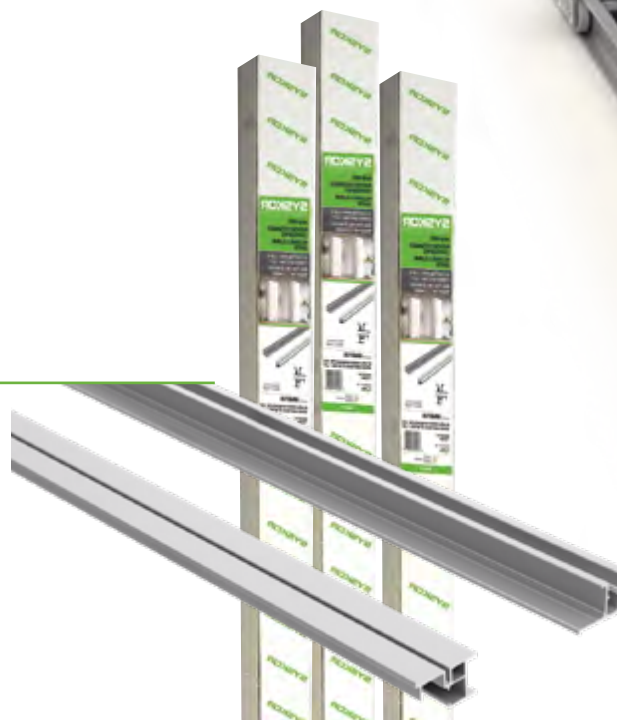
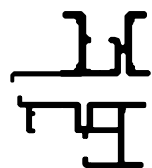



MAQUETA EXPOSITOR FUNCIONAL SISTEMA AXIS FREE PUERTAS PLEGABLES-CORREDERAS

cod. 660AXF000

* Embalaje: 1 unidad

Dimensiones

Alto 300 mm x Largo 600 mm x Ancho 290 mm

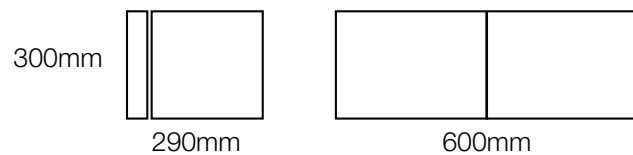



axis
program



SYSKOR
aluminium systems



**SET HERRAJE
PUERTA PLEGABLE
AXIS**

código **640001000**

**kit de 2 hojas
compuesto por:**

- 1 conjunto rueda superior
- 1 conjunto rueda inferior
- 4 bisagras centrales
- 4 bisagras laterales
- 1 plantilla de montaje
bisagra central
- tornillos
- instrucciones

1 conjunto rueda superior



1 conjunto rueda inferior



4 bisagras centrales



4 bisagras laterales



tornillos rosca chapa 4x16



**1 plantilla de montaje de
bisagra central**

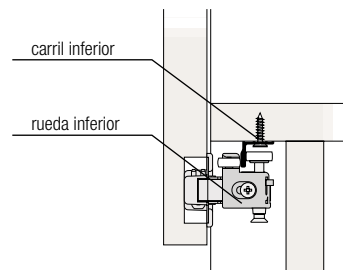
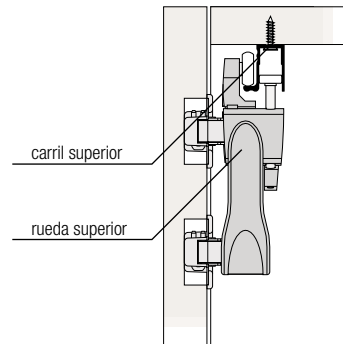

**CARRIL INFERIOR
PUERTA PLEGABLE**

código **642200A02**



Aluminio plata mate



**CARRIL SUPERIOR
PUERTA PLEGABLE**

código **641200A02**



Aluminio plata mate

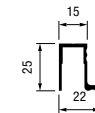

**SERIE
MINIMAL**

**TIRADOR
TBMV1**

código **620260A02**



10 mm

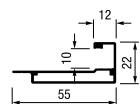

**PERFIL REMATE
PRU10V**

código **126400A02**



revestido "U" completa



**PERFIL "H"
PRH10V**

código **127400A02**



revestido "H" 2 caras

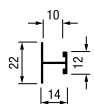

**ASA BATIENTE
MINIMAL 150 mm**

código **600001A02**

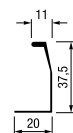

**ASA BATIENTE
MINIMAL 2,6 m**

código **600260A02**



**PLANTILLA AXIS CORTE INGLETE
45°**

código **600040000**



| | | | | | |
|------------------|---------------|------------------|------------------|------------------|------------------|
| longitud | 2,6 m | 4 m | 4 m | 150 mm | 2,6 m |
| embalaje | caja 20 tiras | paquete 10 tiras | paquete 10 tiras | caja 50 unidades | paquete 10 tiras |
| acabados | *** | | | | |
| acabado aluminio | | | | | |
| plata mate | A02 | | | | |

TBMV1 corte recto



TBMV1 corte en inglete



**ESCUADRA
BATIENTE INGLETE**

código **600020000**



zincado plata

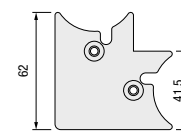

bolsa 4 unidades

**MOLDURA MDF
CRISTAL 4 mm
MIN10**

código **223260100**



MDF



crystal 4 / perfil 10 mm
2,6 m
paquete 10 tiras

**GOMA TR10
CRISTAL 4 mm**

código **104GOMTRA**



pvc transparente

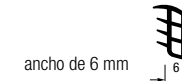

crystal 4 / perfil 10 mm
rollo 100 m

**SERIE
MAX-60**

**TIRADOR
TB60**

código **610260*****



10 mm

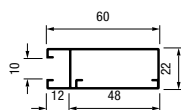

**PERFIL "H"
PHB60**

código **611300*****

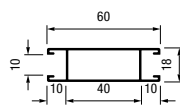

**ESCUADRA
BATIENTE 60**

código **600010000**



aluminio

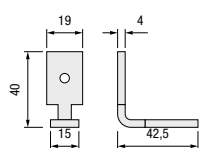

bolsa 4 unidades

**ESCUADRA
BATIENTE INGLETE**

código **600020000**



zincado plata

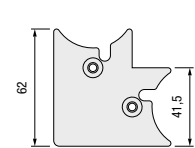

bolsa 4 unidades

**GOMA TR10
CRISTAL 4 mm**

código **104GOMTRA**



pvc transparente



crystal 4 / perfil 10 mm

rollo 100 m

**PLANTILLA AXIS CORTE
INGLETE 45°**

código **600040000**



TB60 corte recto



TB60 corte en inglete



| | | |
|-----------------------|---------------|-----------------|
| longitud | 2,6 m | 3 m |
| embalaje | caja 12 tiras | paquete 6 tiras |
| acabados | *** | |
| acabado aluminio | | |
| plata mate | A02 | • |
| chapa sin barnizar | | |
| roble s/b | C01 | • |
| sapelly s/b | C02 | • |
| fresno s/b | C03 | • |
| cerezo s/b | C04 | • |
| haya s/b | C05 | • |
| pino s/b | C06 | • |
| haya vaporizada s/b | C07 | • |
| papel melamina | | |
| haya vaporizada H-428 | P06 | • |
| roble oscuro A-725 | P07 | • |
| cerezo tajo H-2428 | P08 | • |
| wengue congo D-0427 | P09 | • |
| blanco W-402 | P84 | • |
| plata LY-2609 | P92 | • |

SYSKOR

aluminium systems



Foto: Armario con puertas coplanas Murano Inline - Syskor

Puertas coplanares

2

SYSKOR
aluminium systems



sistema coplanar para armario de 2 puertas Murano Inline Custom

para puertas de hasta 80 Kg con amortiguación de apertura y cierre, corte a medida

murano inline
custom

Exclusivos frentes de armario sobre un mismo plano, corte a medida

Syskor presenta la **última generación** de mecanismos de apertura coplanares que permiten el diseño de armarios del máximo nivel con **frentes limpios y minimalistas** sobre un mismo plano.

El **innovador** desarrollo en estructura **monobloc** del **Murano Inline** garantiza la fabricación de armarios **premium de grandes dimensiones** con puertas de hasta **80 kgs de peso**, incorporando una extraordinaria **suavidad de funcionamiento** con su nuevo sistema de amortiguación **Easy Soft** en apertura y cierre.

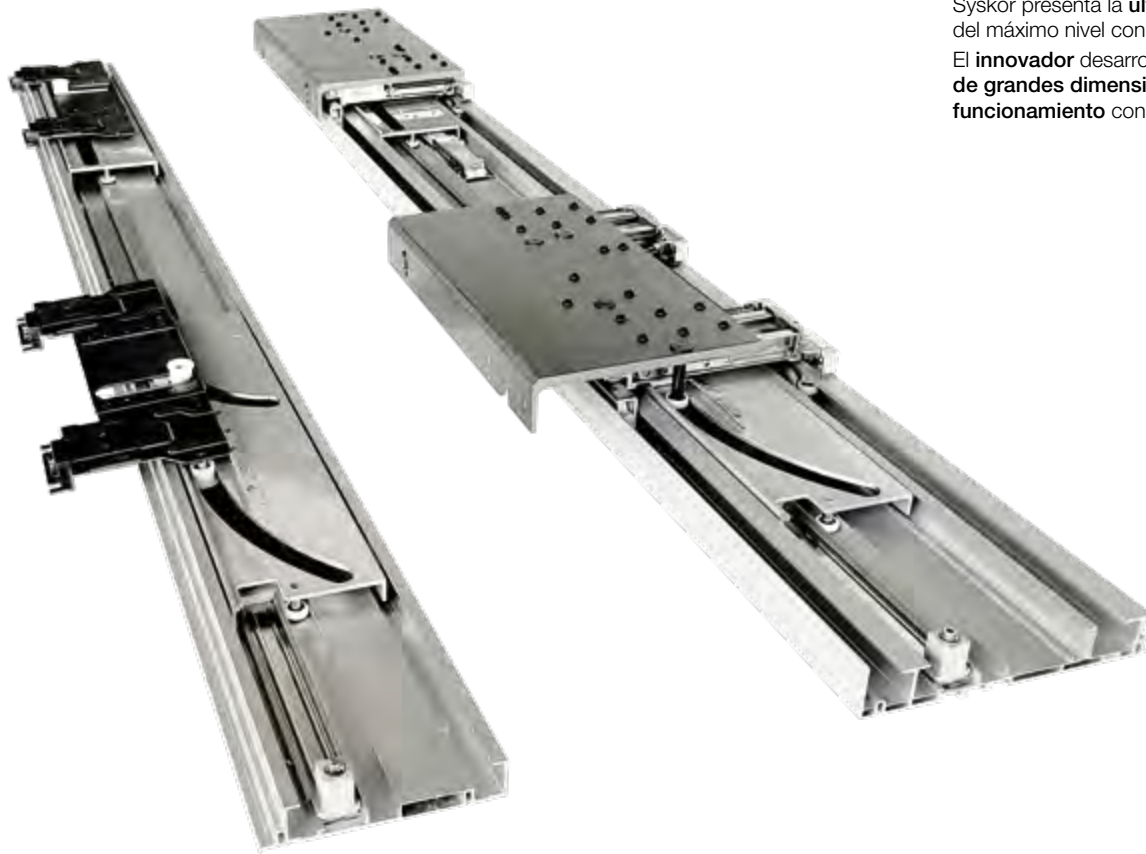

Especificaciones

- Mecanismo coplanar de 2 puertas
- Amortiguación en apertura y cierre
- Peso máximo por puerta: 80 kg
- Anchura de la puerta: 800/1400 mm
- Altura máxima de la puerta: 3000 mm
- Altura de la puerta al suelo: 35 mm
- Espesor de la puerta: 18-45 mm

SISTEMA COPLANAR PARA ARMARIO MURANO INLINE CUSTOM DE 2 PUERTAS CORTE A MEDIDA HASTA 80 KG CON AMORTIGUACIÓN DE APERTURA Y CIERRE

| cod. | Anchura - Rango de corte a medida | altura |
|------------------|-----------------------------------|---------|
| MIL135165 | 1350 mm - 1650 mm | 3000 mm |
| MIL165205 | 1650 mm - 2050 mm | 3000 mm |
| MIL205245 | 2050 mm - 2450 mm | 3000 mm |
| MIL245285 | 2450 mm - 2850 mm | 3000 mm |

* Cálculo de medidas para costados de 19 mm de espesor

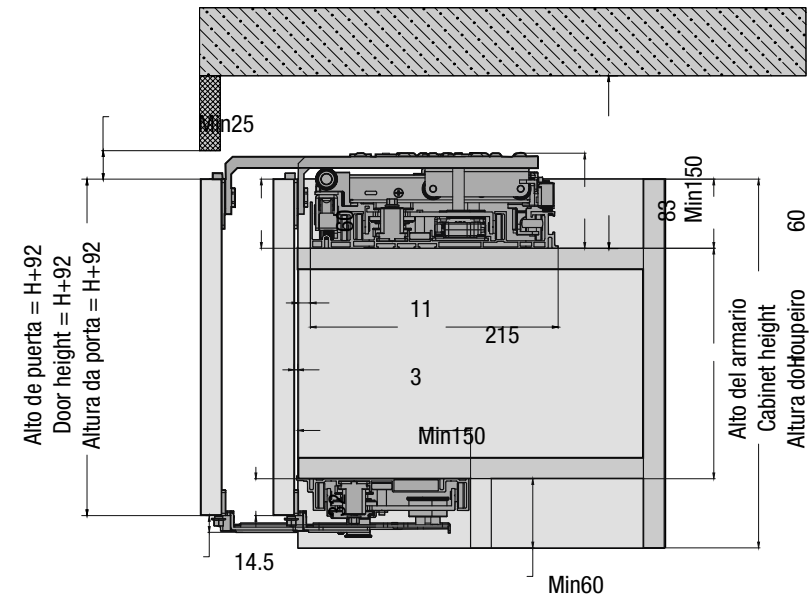
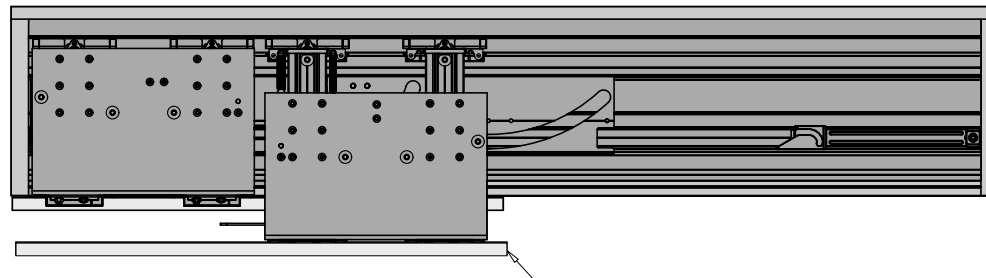



murano inline - sistema coplanar para armario de 2 puertas
para puertas de hasta 60 Kg con amortiguación de apertura y cierre

sistema coplanar para armario de 2 puertas Murano Inline

para puertas de hasta 60 Kg con amortiguación de apertura y cierre



Exclusivos frentes de armario sobre un mismo plano

Syskor presenta la **última generación** de mecanismos de apertura coplanares que permiten el diseño de armarios del máximo nivel con **frentes limpios y minimalistas** sobre un mismo plano.

El **innovador** desarrollo en estructura **monobloc** del **Murano Inline** garantiza la fabricación de armarios **premium de grandes dimensiones** con puertas de hasta **60 kgs de peso**, incorporando una extraordinaria **suavidad de funcionamiento** con su nuevo sistema de amortiguación **Easy Soft** en apertura y cierre.

Especificaciones

- Mecanismo coplanar de 2 puertas
- Amortiguación en apertura y cierre
- Peso máximo por puerta: 60 kg
- Anchura de la puerta: 800/1400 mm
- Altura máxima de la puerta: 3000 mm
- Altura de la puerta al suelo: 35 mm
- Espesor de la puerta: 18-45 mm

SISTEMA COPLANAR PARA ARMARIO MURANO INLINE DE 2 PUERTAS HASTA 60 KG CON AMORTIGUACIÓN DE APERTURA Y CIERRE

| cod. | A* ancho mueble | B* ancho herraje | altura | |
|-----------|--------------------|---------------------|---------|---|
| MIL001600 | 1600 mm | 1560 mm | 3000 mm | • |
| MIL001800 | 1800 mm | 1760 mm | 3000 mm | • |
| MIL002000 | 2000 mm | 1960 mm | 3000 mm | • |
| MIL002200 | 2200 mm | 2160 mm | 3000 mm | • |
| MIL002400 | 2400 mm | 2360 mm | 3000 mm | • |
| MIL002600 | 2600 mm | 2560 mm | 3000 mm | • |

* Cálculo de medidas para costados de 19 mm de espesor

Cuadro monobloc que incorpora:

- Máxima rigidez estructural
- Instalación y ajustes rápidos e intuitivos

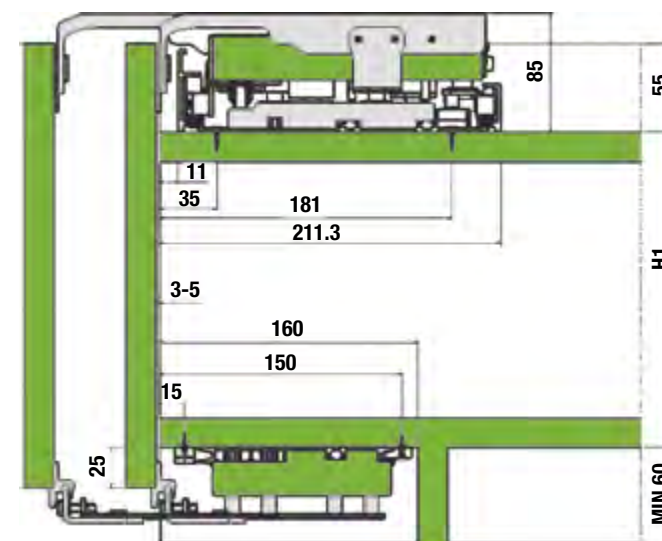
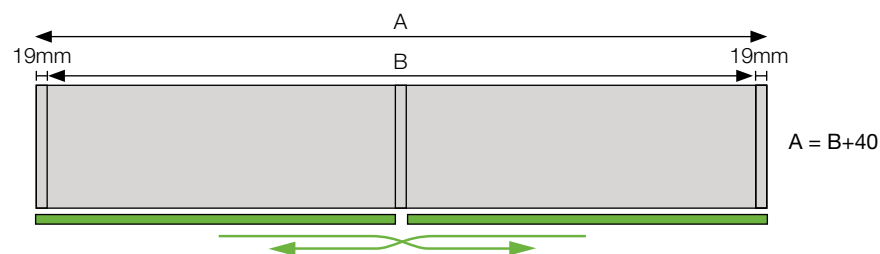

SYSKOR
aluminium systems



Foto: Armario con 3 puertas correderas colgantes de aluminio V80 Essence Black Mokka

Puertas correderas colgantes superpuestas

3

SYSKOR
aluminium systems

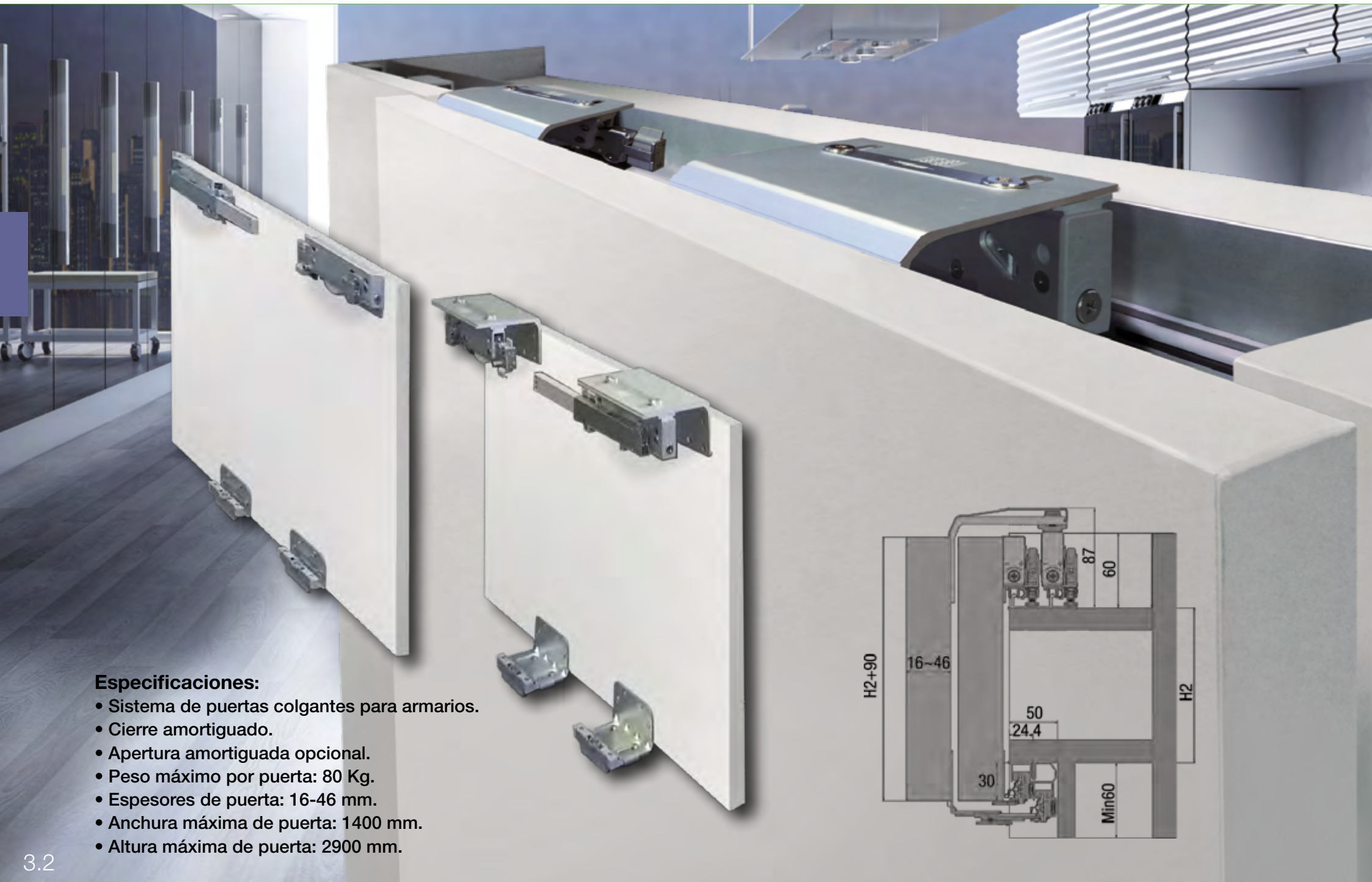

Especificaciones:

- Sistema de puertas colgantes para armarios.
- Cierre amortiguado.
- Apertura amortiguada opcional.
- Peso máximo por puerta: 80 Kg.
- Espesores de puerta: 16-46 mm.
- Anchura máxima de puerta: 1400 mm.
- Altura máxima de puerta: 2900 mm.

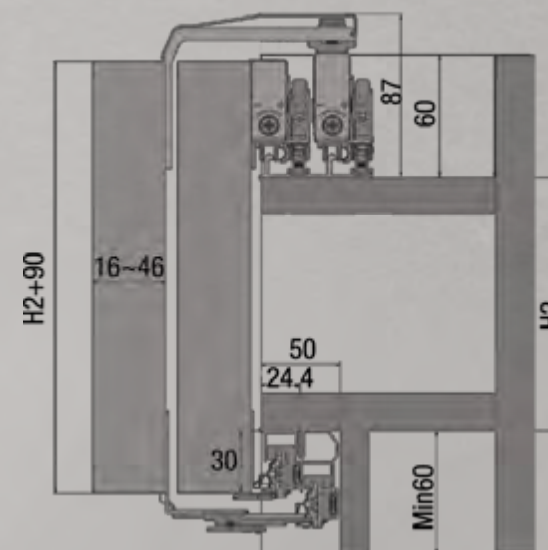

puertas correderas colgantes para armario - cierre amortiguado

tablero de 16 a 46 mm / 80 Kg - puertas de aluminio (tablero de 10mm) / 60Kg

Volare V80 Adapta

program



KIT CARROS VOLARE V80-2 ADAPTA PUERTA INTERIOR Y PUERTA EXTERIOR ARMARIO DE 2 PUERTAS

cod. V80A00K2P

Kit para armario de 2 puertas: ruedas altas y bajas para una puerta exterior y una puerta interior de madera con amortiguación en el cierre

Caja interior autoventa de 1 kit
* Embalaje exterior de 4 kits



KIT CARROS VOLARE V80-3 ADAPTA PUERTA INTERIOR Y PUERTA EXTERIOR ARMARIO DE 3 PUERTAS

cod. V80A00K3P

Kit para armario de 3 puertas: ruedas altas y bajas para una puerta exterior y dos puertas interiores de madera con amortiguación en el cierre

Caja interior autoventa de 1 kit
* Embalaje exterior de 4 kits

1 KIT FRENO AMORTIGUACIÓN ALTO-BAJO V80 ADAPTA

cod. V80A00K1F

* Kit opcional que permite la incorporación de apertura amortiguada

Caja interior autoventa de 1 kit
* Embalaje exterior de 50 kits



Adaptable
en anchura





Volare V60 Adapta Puertas colgantes de aluminio

Sistemas de cuadro de aluminio para puertas correderas colgantes compatible con el sistema de rodaduras Adapta.

- Tablero de 10 mm.
- Cristal de 4 y 6 mm.
- Peso máximo de puerta: 60 Kg.
- Espesor de puerta: 29 mm.
- Anchura máxima de puerta: 1200 mm.
- Altura máxima de puerta: 2500 mm.
- Acabados: Anodizado Plata Mate, Blanco Chamonix, Black Mokka

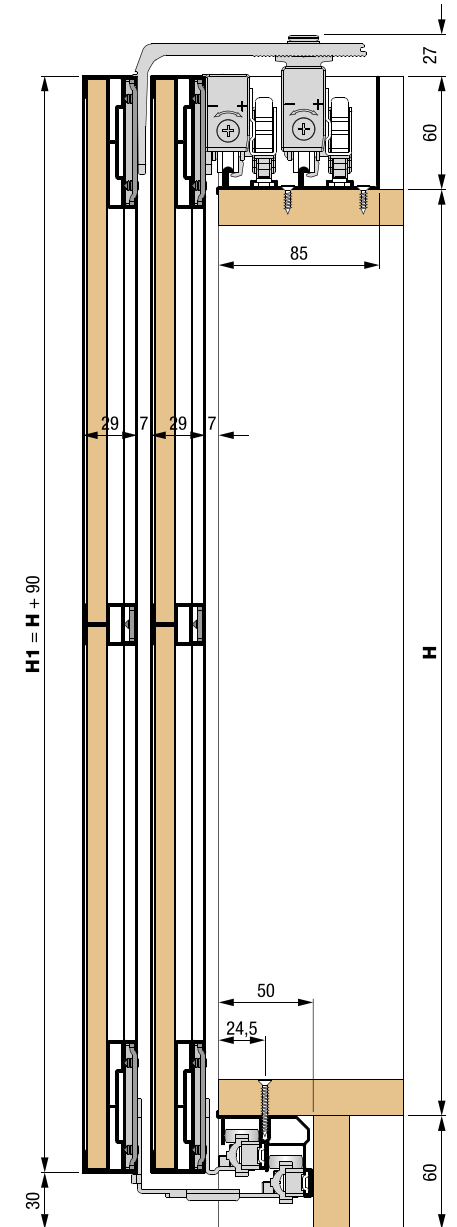
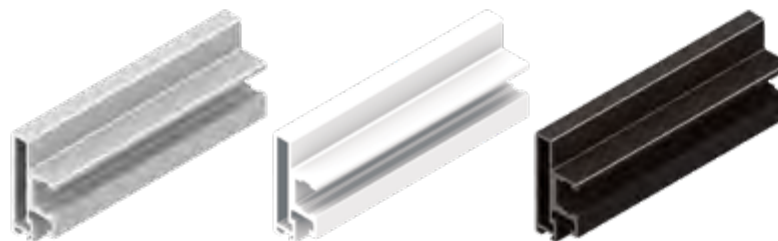

kits de puertas correderas colgantes superpuestas de aluminio

tablero de 10 mm. cristal de 4 y 6 mm

KIT 2 PUERTAS DE ALUMINIO VOLARE V60 ADAPTA ARMARIO SIMÉTRICO

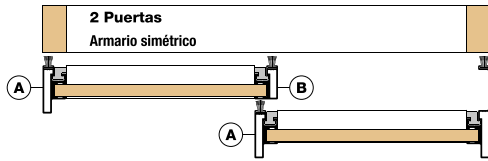

| cod. | |
|-----------|---|
| VK60S2A02 | • |
| VK60S2AM1 | • |
| VK60S2AM9 | • |

Embalaje:
caja de 1 kit

Kit compuesto de:

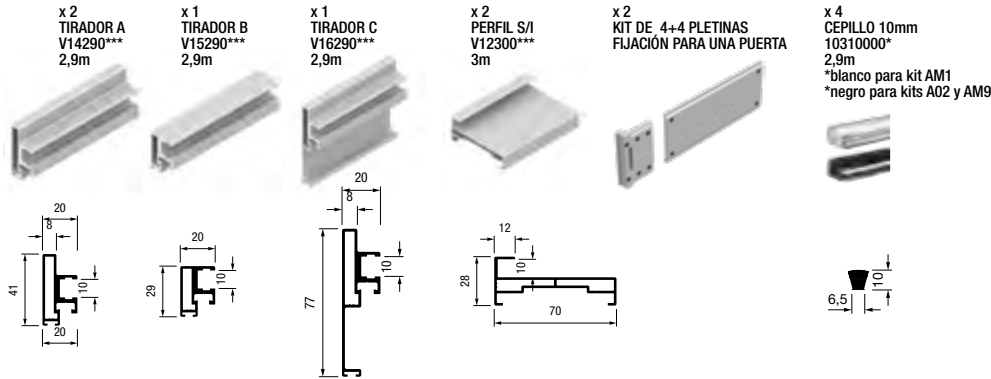

KIT 2 PUERTAS DE ALUMINIO VOLARE V60 ADAPTA ARMARIO ASIMÉTRICO

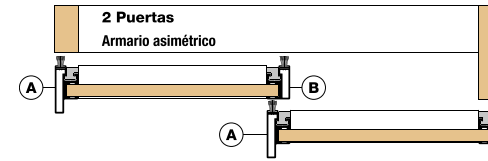

| cod. | |
|-----------|---|
| VK60A2A02 | • |
| VK60A2AM1 | • |
| VK60A2AM9 | • |

Embalaje:
caja de 1 kit

Kit compuesto de:

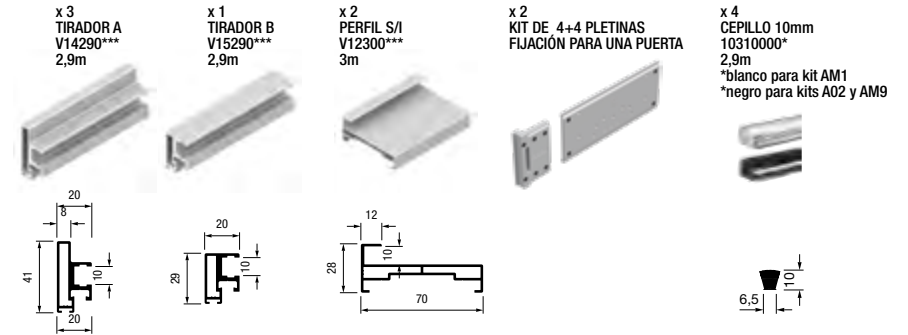

KIT 3 PUERTAS DE ALUMINIO VOLARE V60 ADAPTA

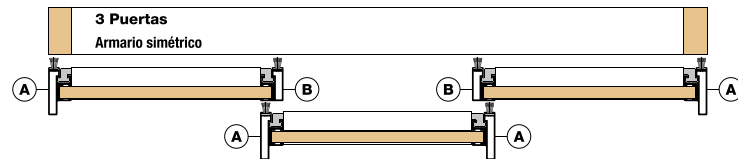

| cod. | |
|-----------|---|
| VK60S3A02 | • |
| VK60S3AM1 | • |
| VK60S3AM9 | • |

Embalaje:
caja de 1 kit

Kit compuesto de:

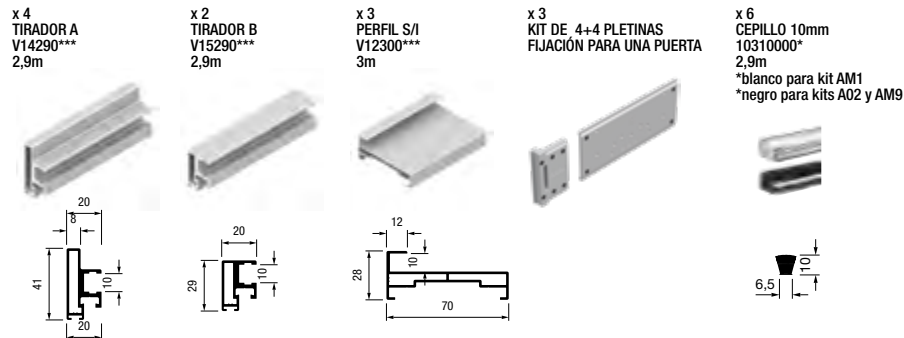

KIT 2 PERFILES CENTRALES H

Kit compuesto de:

2 PERFILES CENTRALES H
V13200***
2 x 1,50m

2+2 PLETINAS
FIJACIÓN CENTRAL
V0002000

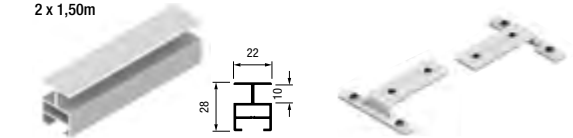

| cod. | |
|-----------|---|
| VK60VHA02 | • |
| VK60VHAM1 | • |
| VK60VHAM9 | • |

Embalaje:
caja de 1 kit

Anodizado A02
Plata Mate

Mate

Lacado AM1
Blanco Chamonix

RAL 9003 Mate texturizado

Lacado AM9
Black Mokka

RAL 9005 Mate texturizado

TIRADOR "A"

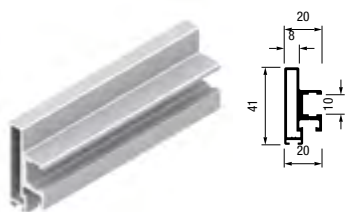

cod.

V14290A02



V14290AM1



V14290AM9



Tiras de 2,9 m
Embalaje: caja de 10 tiras

TIRADOR "B"

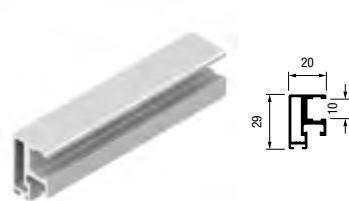

cod.

V15290A02



V15290AM1



V15290AM9



Tiras de 2,9 m
Embalaje: caja de 10 tiras

TIRADOR "C"

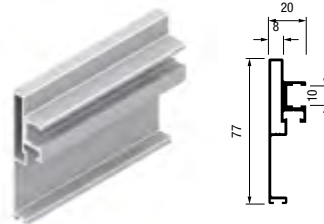

cod.

V16290A02



V16290AM1



V16290AM9



Tiras de 2,9 m
Embalaje: caja de 10 tiras

PERFIL INFERIOR Y SUPERIOR

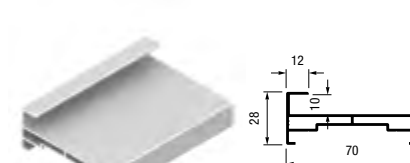

cod.

V12300A02



V12300AM1



V12300AM9



Tiras de 3 m
Embalaje: paquete de 10 tiras

PERFIL CENTRAL "H"



cod.

V13300A02



V13300AM1



V13300AM9



Tiras de 3 m
Embalaje: paquete de 4 tiras

GOMA TR10 CRISTAL 4 mm

cod. 104GOMTRA



pvc transparente

ancho de 6 mm



crystal 4 / perfil 10 mm

rollo 100 m

GOMA TR10 CRISTAL 6 mm

cod. 804004000



pvc transparente

ancho de 4 mm



crystal 6 / perfil 10 mm

rollo 100 m

CEPILLO INTERNO

cod. 103100001 blanco

cod. 103100002 negro



para perfiles superiores y tiradores

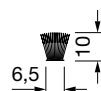

1 bobina de 300 m

KIT DE 4+4 PLETINAS FIJACIÓN PARA UNA PUERTA DE ALUMINIO ADAPTA

cod. V80A01000



compuesto por:
4+4 pletinas de fijación
tornillos

caja interior de 1 kit
caja exterior de 6 kits

KIT 2 PLETINAS FIJACIÓN CENTRAL

cod. V00002000



compuesto por:
2 pletinas
8 tornillos M5x6

1 bolsa de 2 pletinas
caja exterior de 20 kits

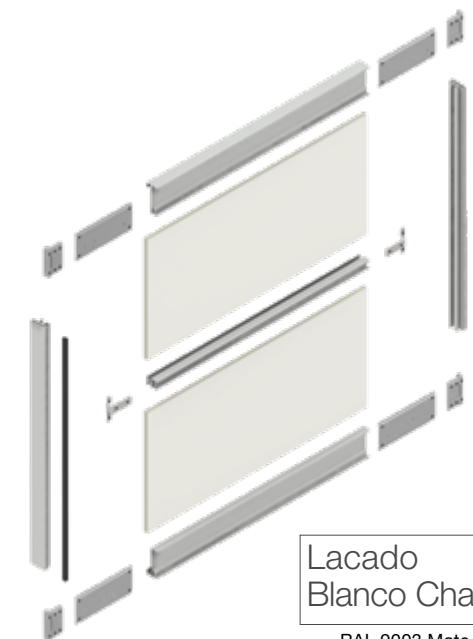

Lacado **AM1**
Blanco Chamonix

RAL 9003 Mate texturizado

Anodizado **A02**
Plata Mate

Lacado **AM9**
Black Mokka

Mate

RAL 9005 Mate texturizado

KIT CARRIL SUPERIOR Y CARRIL INFERIOR VOLARE V80 ADAPTA



Anodizado A02
Plata Mate

Mate



Lacado AM1
Blanco Chamonix

RAL 9003 Mate texturizado



Lacado AM9
Black Mokka

RAL 9005 Mate texturizado

| cod. | acabados | longitud |
|------------------|----------------------|-----------------------|
| V80ACK200 | anodizado plata mate | set carriles de 2 m • |
| V80ACK300 | anodizado plata mate | set carriles de 3 m • |
| V80ACK400 | anodizado plata mate | set carriles de 4 m • |

* Precio por kit de tira alta y tira baja

Caja interior autoventa de 1 kit
Embalaje exterior de 4 kits

| cod. | acabados | longitud |
|------------------|------------------------|-----------------------|
| V80AWK200 | lacado blanco chamonix | set carriles de 2 m • |
| V80AWK300 | lacado blanco chamonix | set carriles de 3 m • |
| V80AWK400 | lacado blanco chamonix | set carriles de 4 m • |

* Precio por kit de tira alta y tira baja

Caja interior autoventa de 1 kit
Embalaje exterior de 4 kits

| cod. | acabados | longitud |
|------------------|--------------------|-----------------------|
| V80AMK200 | lacado black mokka | set carriles de 2 m • |
| V80AMK300 | lacado black mokka | set carriles de 3 m • |
| V80AMK400 | lacado black mokka | set carriles de 4 m • |

* Precio por kit de tira alta y tira baja

Caja interior autoventa de 1 kit
Embalaje exterior de 4 kits

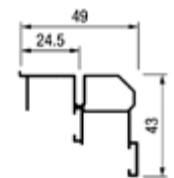
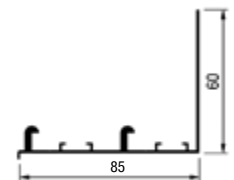

Essence es un **sistema minimalista de tiradores de aluminio** compatible con los sistemas de carros colgantes Syskor **Volare V80 Adapta** y **Volare V35**.

- Acabados: **Lacado Blanco - A01**
Anodizado Plata Mate - A02
Anodizado Inox Mate - A12
Lacado Blanco Chamonix - AM1
Lacado Black Mokka - AM9
- Kits para armarios de **2 y 3 puertas**.
- Versiones para armarios de **construcción simétrica y asimétrica**.
- Utilizable para espesores de **puerta de madera de 19 mm**.

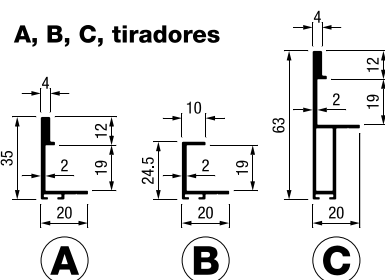
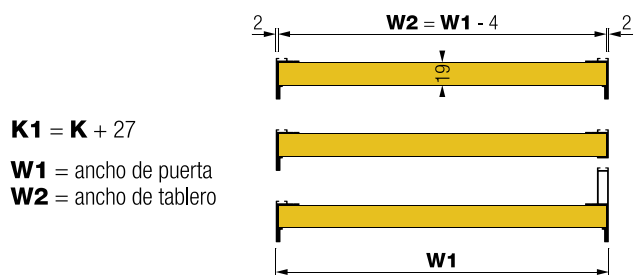

Lacado Blanco A01

RAL 9110 Brillante

Anodizado Plata Mate A02

Mate

Anodizado Inox Mate A12

Mate

Lacado Blanco Chamonix AM1

RAL 9003 Mate texturizado

Lacado Black Mokka AM9

RAL 9005 Mate texturizado

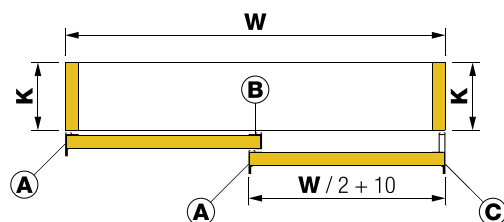

KIT DE TIRADORES Y CEPILLOS PARA ARMARIO SIMÉTRICO DE 2 PUERTAS

| | | |
|----------------|------------------------|---|
| cod. VKT2PSA01 | lacado blanco | • |
| cod. VKT2PSA02 | anodizado plata mate | • |
| cod. VKT2PSA12 | anodizado inox mate | • |
| cod. VKT2PSAM1 | lacado blanco chamonix | • |
| cod. VKT2PSAM9 | lacado black mokka | • |

Kit compuesto de:

- Tirador A: 2 tiras x 2,6m
- Tirador B: 1 tira x 2,6m
- Tirador C: 1 tira x 2,6m
- Cepillo 6,5mm: 4 tiras

Caja interior autoventa de 1 kit - Embalaje exterior de 4 kits

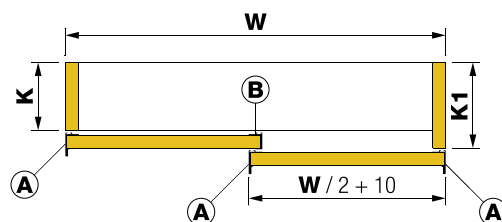

KIT DE TIRADORES Y CEPILLOS PARA ARMARIO ASIMÉTRICO DE 2 PUERTAS

| | | |
|----------------|------------------------|---|
| cod. VKT2PAA01 | lacado blanco | • |
| cod. VKT2PAA02 | anodizado plata mate | • |
| cod. VKT2PAA12 | anodizado inox mate | • |
| cod. VKT2PAAM1 | lacado blanco chamonix | • |
| cod. VKT2PAAM9 | lacado black mokka | • |

Kit compuesto de:

- Tirador A: 3 tiras x 2,6m
- Tirador B: 1 tira x 2,6m
- Cepillo 6,5mm: 4 tiras

Caja interior autoventa de 1 kit - Embalaje exterior de 4 kits

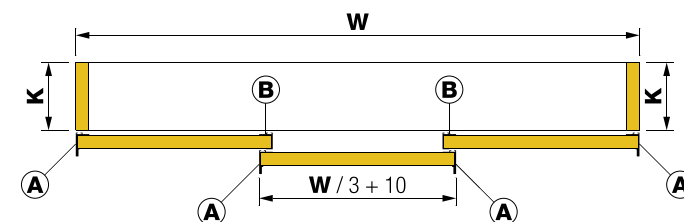

KIT DE TIRADORES Y CEPILLOS PARA ARMARIO SIMÉTRICO DE 3 PUERTAS

| | | |
|----------------|------------------------|---|
| cod. VKT3PSA01 | lacado blanco | • |
| cod. VKT3PSA02 | anodizado plata mate | • |
| cod. VKT3PSA12 | anodizado inox mate | • |
| cod. VKT3PSAM1 | lacado blanco chamonix | • |
| cod. VKT3PSAM9 | lacado black mokka | • |

Kit compuesto de:

- Tirador A: 4 tiras x 2,6m
- Tirador B: 2 tiras x 2,6m
- Cepillo 6,5mm: 6 tiras

Caja interior autoventa de 1 kit - Embalaje exterior de 4 kits

TIRADOR VT19A260***

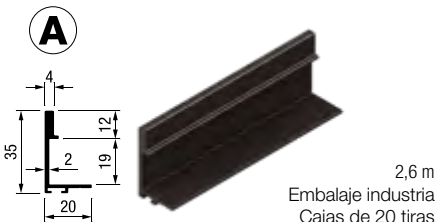

| | | |
|------------------|------------------------|---|
| cod. VT19A260A01 | lacado blanco | • |
| cod. VT19A260A02 | anodizado plata mate | • |
| cod. VT19A260A12 | anodizado inox mate | • |
| cod. VT19A260AM1 | lacado blanco chamonix | • |
| cod. VT19A260AM9 | lacado black mokka | • |

TIRADOR VT19B260***

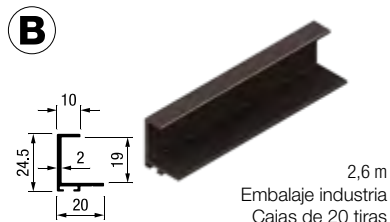

| | | |
|------------------|------------------------|---|
| cod. VT19B260A01 | lacado blanco | • |
| cod. VT19B260A02 | anodizado plata mate | • |
| cod. VT19B260A12 | anodizado inox mate | • |
| cod. VT19B260AM1 | lacado blanco chamonix | • |
| cod. VT19B260AM9 | lacado black mokka | • |

TIRADOR VT19C260***

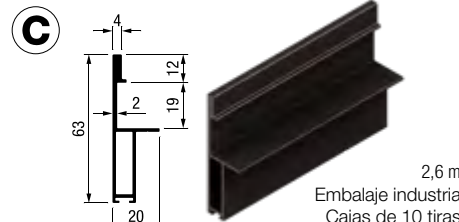

| | | |
|------------------|------------------------|---|
| cod. VT19C260A01 | lacado blanco | • |
| cod. VT19C260A02 | anodizado plata mate | • |
| cod. VT19C260A12 | anodizado inox mate | • |
| cod. VT19C260AM1 | lacado blanco chamonix | • |
| cod. VT19C260AM9 | lacado black mokka | • |

CEPILLO DE 6,5MM

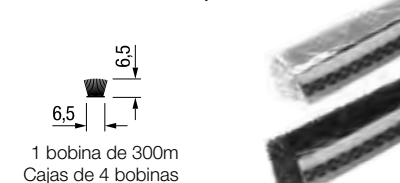

| | | |
|----------------|--------|---|
| cod. 103065001 | blanco | • |
| cod. 103065002 | negro | • |

KIT CARROS VOLARE V35 PUERTA INTERIOR Y PUERTA EXTERIOR ARMARIO DE 2 PUERTAS

cod. V35S2P000

Caja interior autoventa de 1 kit
* Embalaje exterior de 10 kits

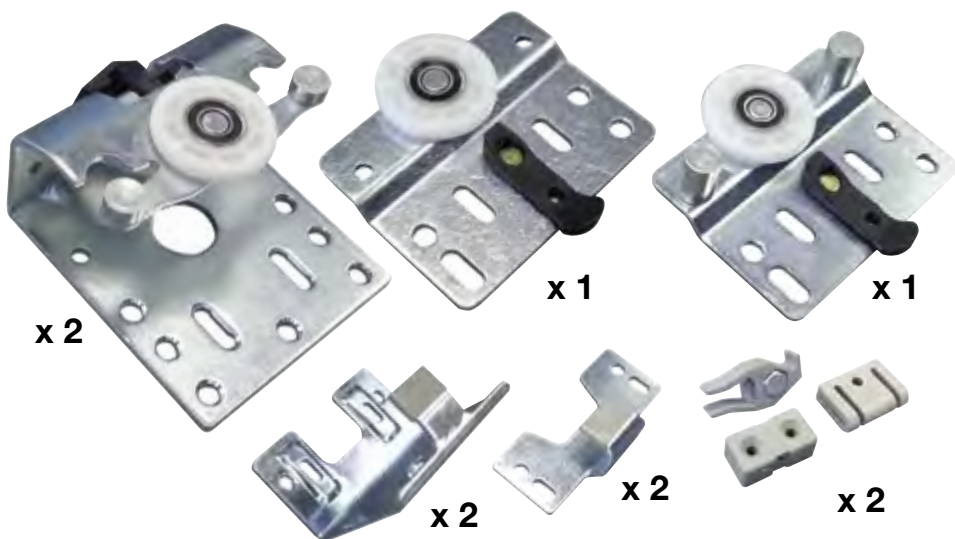

2 puertas

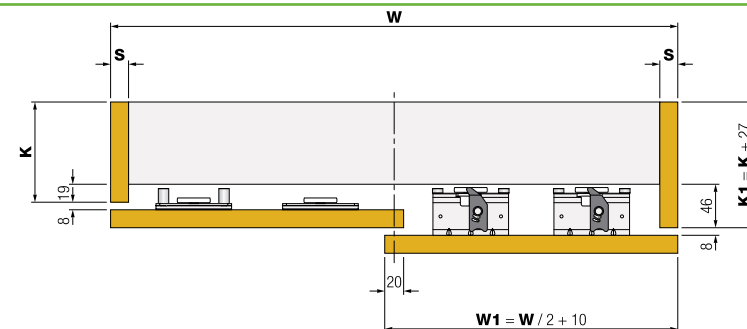

Especificaciones

- Sistema de puertas colgantes para armarios de 2 puertas.
- Peso máximo por puerta: 35 Kg.
- Espesores de puerta: 16-21 mm.
- Anchura máxima de puerta: 1000 mm.
- Altura máxima de puerta: 2400 mm.

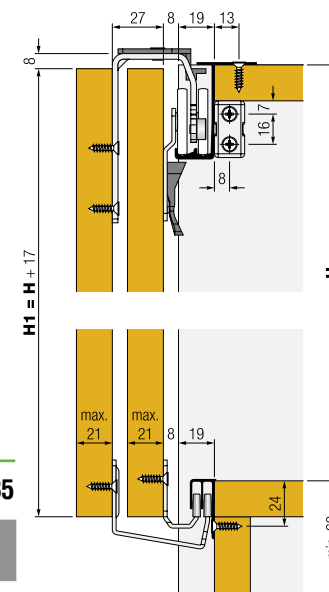

KIT CARRIL SUPERIOR Y CARRIL INFERIOR VOLARE V35

| cod. | longitud | |
|-----------|---------------------|---|
| V35001200 | set carriles de 2 m | • |
| V35001300 | set carriles de 3 m | • |

Caja interior autoventa de 1 kit
* Embalaje exterior de 4 kits

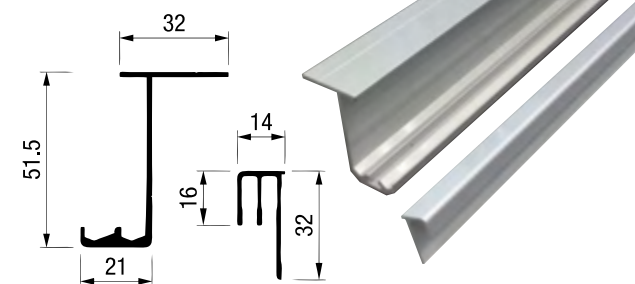

sistema de correderas colgantes para armario - puertas de madera
para tablero de 16 a 21 mm - puertas de 35 Kg - 3 puertas

**KIT CARROS VOLARE V35 PUERTA INTERIOR Y
PUERTA EXTERIOR ARMARIO DE 3 PUERTAS**

cod. V35S3P000

Caja interior autoventa de 1 kit
* Embalaje exterior de 10 kits

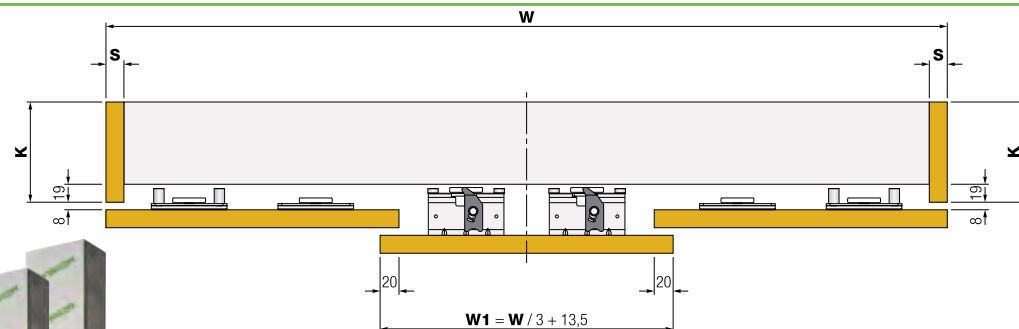
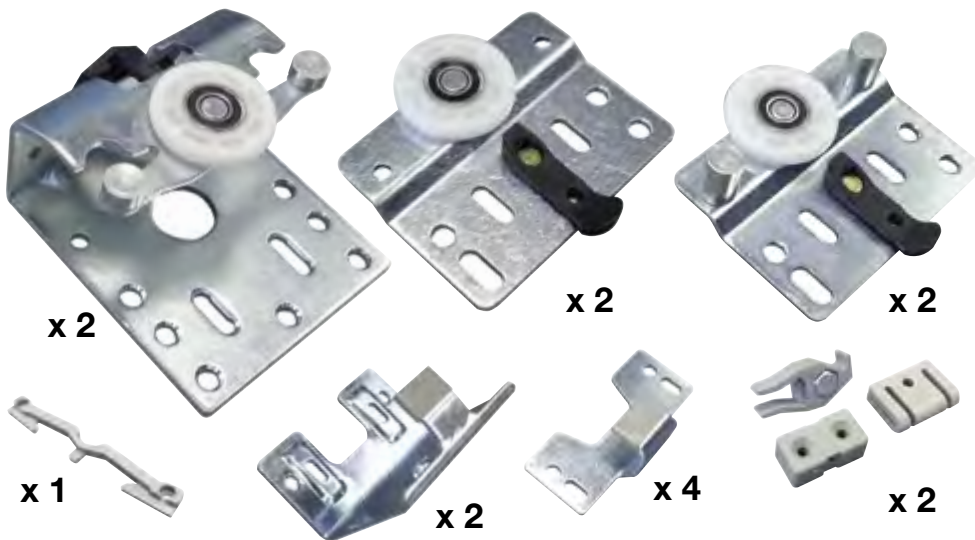

Especificaciones

- Sistema de puertas colgantes para armarios de 3 puertas.
- Peso máximo por puerta: 35 Kg.
- Espesores de puerta: 16-21 mm.
- Anchura máxima de puerta: 1000 mm.
- Altura máxima de puerta: 2400 mm.

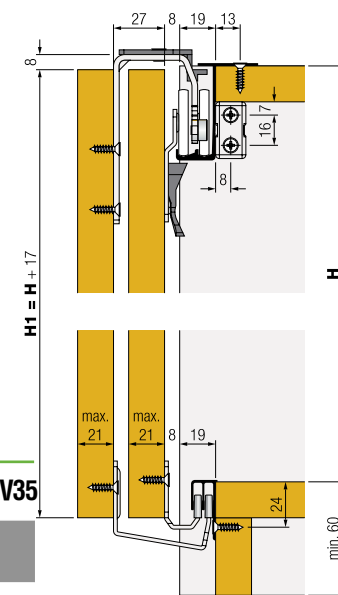

KIT CARRIL SUPERIOR Y CARRIL INFERIOR VOLARE V35

| cod. | longitud |
|-----------|---------------------|
| V35001200 | set carriles de 2 m |
| V35001300 | set carriles de 3 m |

Caja interior autoventa de 1 kit
* Embalaje exterior de 4 kits

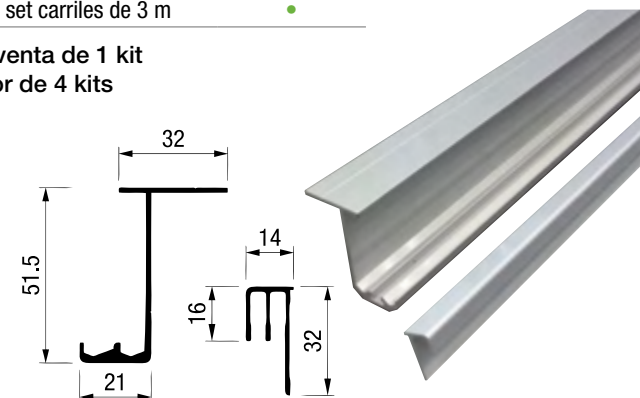





KIT DE 1 TENSOR DE PUERTAS cod. V00000001

Bolsa de 1 kit
Caja de 20 kits

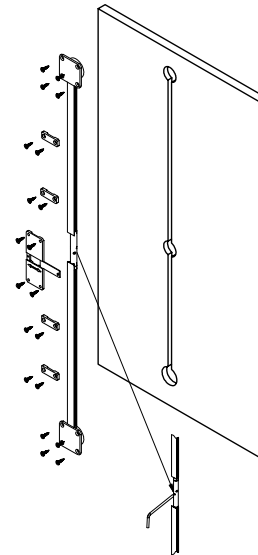

PUERTAS DE HASTA
600 MM DE ANCHO

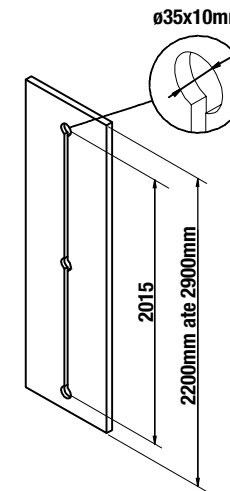

PUERTAS DE 600-1200 MM
DE ANCHO

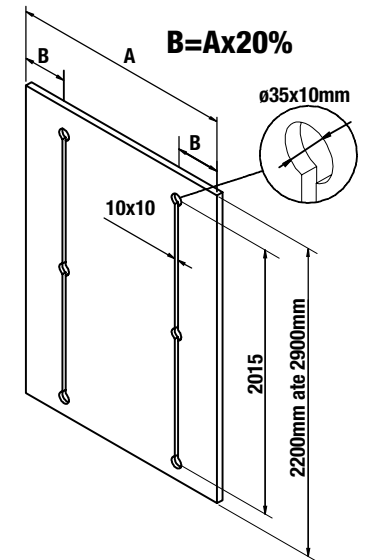

SYSKOR

aluminium systems



Foto: Armario empotrado - perfiles Terra Top Line Black Mokka - altura 2600 mm

Puertas correderas apoyadas

4

SYSKOR
aluminium systems

SYSKOR

aluminium systems



Foto: Armario de tres puertas correderas sistema Terra de Syskor en acabado black mokka

puertas correderas apoyadas

Puertas correderas de aluminio a medida para **armarios empotrados**, roperos y vestidores.

La más completa gama de diseños de perfiles y acabados de aluminio del mercado.

Mecanismo exclusivo patentado integrado **«Easy soft» de cierre y apertura suave** para un funcionamiento silencioso y cómodo y un montaje rápido y sencillo.

Rodamientos de bolas, carros de alta precisión y estructuras de aluminio de gran resistencia para **puertas de hasta 80 kg.**

Terra Top Line

puertas de aluminio acabado "Top"

Terra Classic

puertas de aluminio acabado "Classic"

Terra Base

puertas de aluminio rueda oculta

Terra W40

para puertas de madera de hasta 40 Kgs

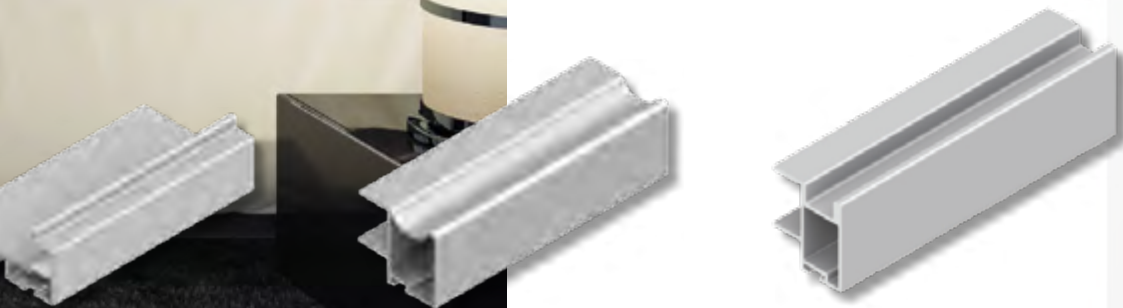

terra top line
program

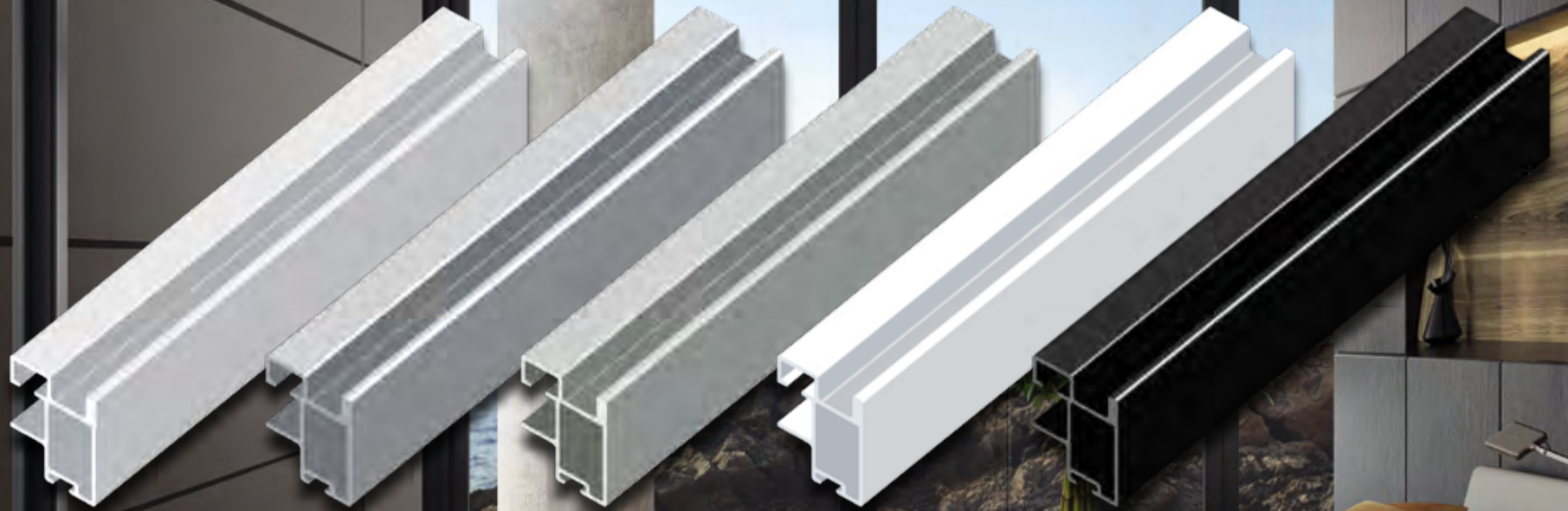

SYSKOR
aluminium systems

puertas correderas de aluminio

Cada caja contiene todo lo necesario para el montaje de una puerta corredera.



composición del kit de puerta:

- 2 ruedas inferiores
- 2 ruedas superiores
- tornillería varia
- cepillo
- 2 perfiles tiradores (2 x 2,6 m)
- 1 perfil horizontal (superior / inferior) (1 x 2 m)
- *tablero no incluido



Lacado Blanco A01

RAL 9110 Brillante

Anodizado Plata Mate A02

Mate

Anodizado Inox Mate A12

Mate

Lacado Blanco Chamonix AM1

RAL 9003 Mate texturizado

Lacado Black Mokka AM9

RAL 9005 Mate texturizado

KIT PUERTA KP-TR10MIN75

Kit de 1 puerta de hasta 2,6m x 1m
para tablero de 10 mm y carriles de 75 mm

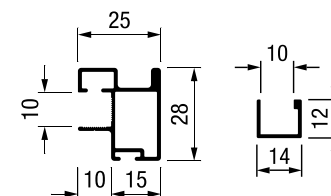
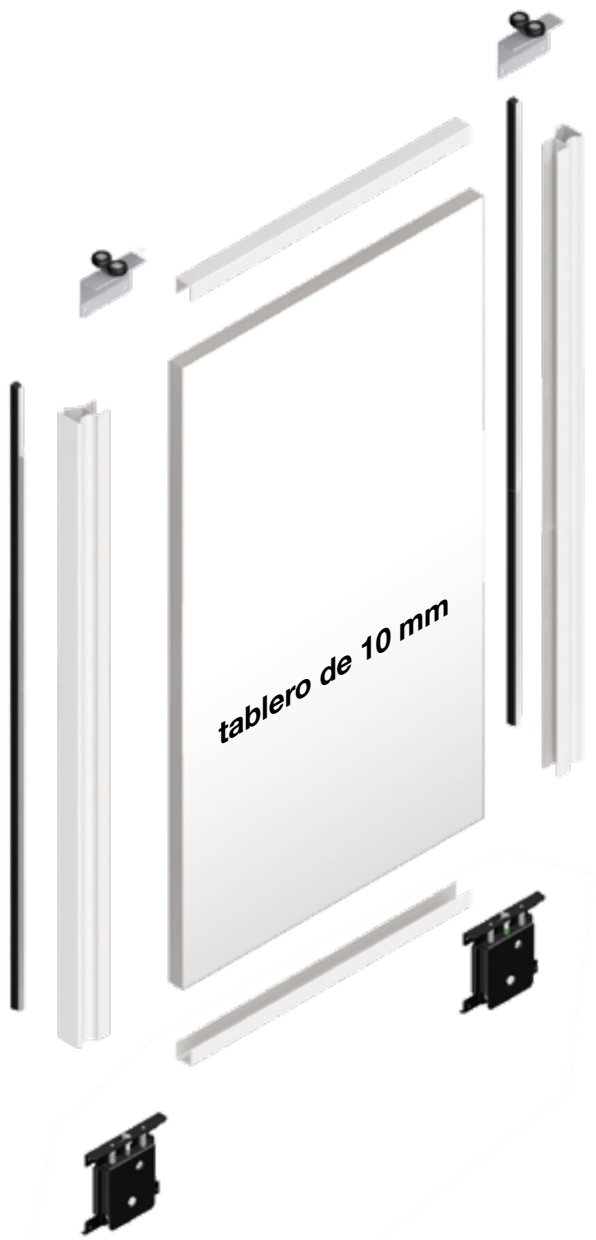

cod. **34M000*****

| acabados | *** |
|----------------------|-----|
| lacado blanco | A01 |
| anodizado plata mate | A02 |
| anodizado inox mate | A12 |
| blanco chamonix | AM1 |
| black mokka | AM9 |

caja interior autoventa de 1 kit
* embalaje exterior de 4 kits (tablero no incluido)

composición del kit de puerta:

- 2 ruedas inferiores
- 2 ruedas superiores
- 2 perfiles tiradores (2 x 2,6 m)
- 1 perfil horizontal (superior / inferior) (1 x 2 m)
- tornillería varia
- cepillo

*tablero no incluido

Lacado Blanco A01

RAL 9110 Brillante

Anodizado Plata Mate A02

Mate

Anodizado Inox Mate A12

Mate

Lacado Blanco Chamonix AM1

RAL 9003 Mate texturizado

Lacado Black Mokka AM9

RAL 9005 Mate texturizado

KIT GUÍAS KG75

Kit de 1 guía alta, 1 guía baja de 75 mm y piezas de fijación
Medidas de 2-3-4 m

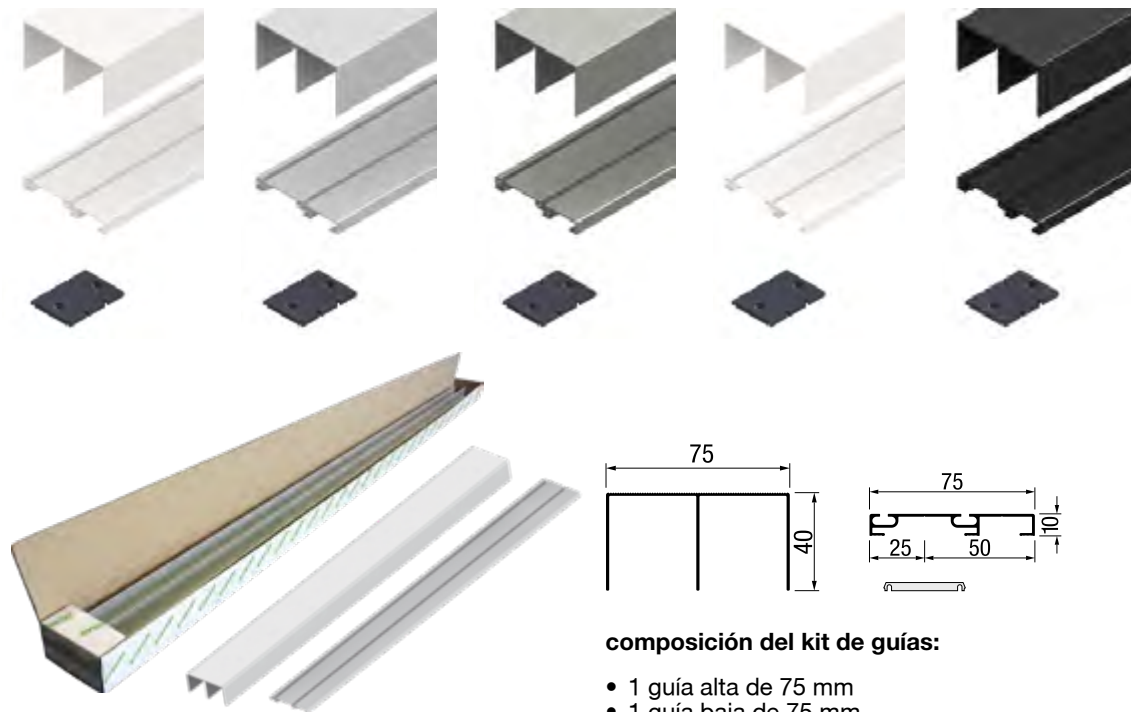

composición del kit de guías:

- 1 guía alta de 75 mm
- 1 guía baja de 75 mm
- Piezas de anclaje carril bajo

| cod. | 312***200 | 312***300 | 312***400 |
|---------------------------------|-----------|-----------|-----------|
| | kit 2m | kit 3m | kit 4m |
| acabados *** | | | |
| lacado blanco A01 | • | • | • |
| anodizado plata mate A02 | • | • | • |
| anodizado inox mate A12 | • | • | • |
| blanco chamonix AM1 | • | • | • |
| black mokka AM9 | • | • | • |

caja interior autoventa de 1 kit
* embalaje exterior de 4 kits

Lacado Blanco **A01**

RAL 9110 Brillante

Anodizado Plata Mate **A02**

Mate

Anodizado Inox Mate **A12**

Mate

Lacado Blanco Chamonix **AM1**

RAL 9003 Mate texturizado

Lacado Black Mokka **AM9**

RAL 9005 Mate texturizado

KIT "H" PRH 10V 2+2

Kit de 2 perfiles japonesa "H" (2 tiras de 2 m)

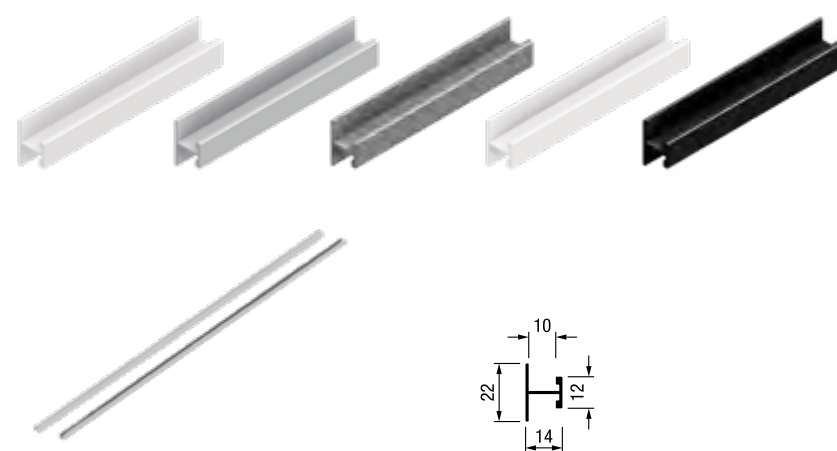

composición del kit de japonesas "H":

- 2 tiras de 2 m.

cod. **3KH127*****

| acabados *** | |
|---------------------------------|---|
| lacado blanco A01 | • |
| anodizado plata mate A02 | • |
| anodizado inox mate A12 | • |
| blanco chamonix AM1 | • |
| black mokka AM9 | • |

KIT PUERTA KP-TR16MIN75

Kit de 1 puerta de hasta 2,6m x 1m
para tablero de 16 mm y carriles de 75 mm

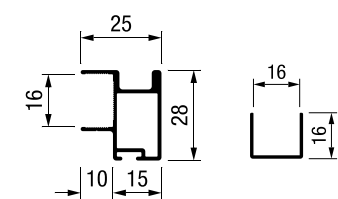
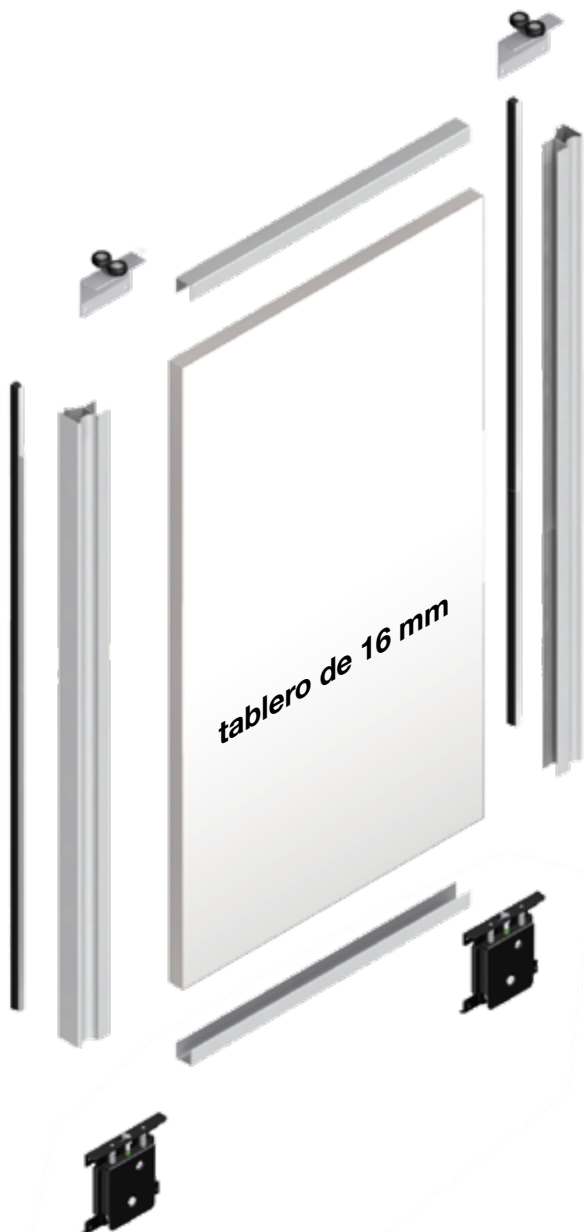

cod. **35M000*****

| acabados | *** |
|----------------------|-----|
| lacado blanco | A01 |
| anodizado plata mate | A02 |
| anodizado inox mate | A12 |
| blanco chamonix | AM1 |
| black mokka | AM9 |

caja interior autoventa de 1 kit
* embalaje exterior de 4 kits (tablero no incluido)

composición del kit de puerta:

- 2 ruedas inferiores
- 2 ruedas superiores
- 2 perfiles tiradores (2 x 2,6 m)
- 1 perfil horizontal (superior / inferior) (1 x 2 m)
- tornillería varia
- cepillo

*tablero no incluido

Lacado Blanco A01

RAL 9110 Brillante

Anodizado Plata Mate A02

Mate

Anodizado Inox Mate A12

Mate

Lacado Blanco Chamonix AM1

RAL 9003 Mate texturizado

Lacado Black Mokka AM9

RAL 9005 Mate texturizado

KIT GUÍAS KG75

Kit de 1 guía alta, 1 guía baja de 75 mm y piezas de fijación
Medidas de 2-3-4 m

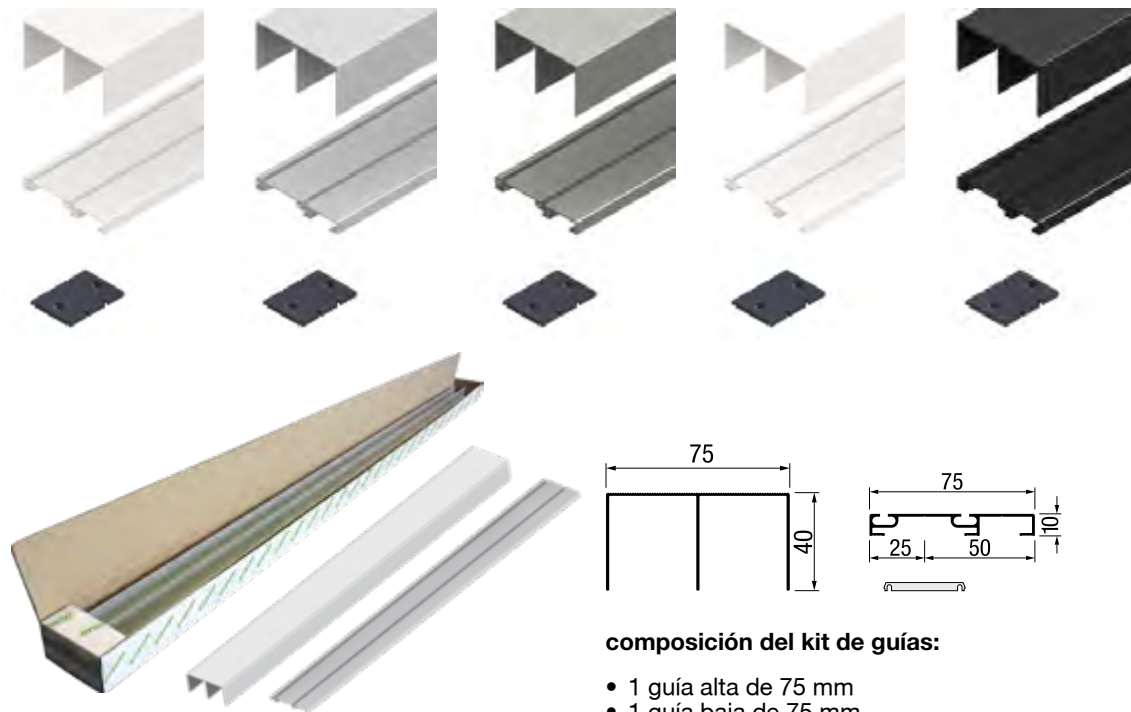

composición del kit de guías:

- 1 guía alta de 75 mm
- 1 guía baja de 75 mm
- Piezas de anclaje carril bajo

| cod. | 312***200 kit 2m | 312***300 kit 3m | 312***400 kit 4m |
|--------------------------|---------------------|---------------------|---------------------|
| acabados *** | | | |
| lacado blanco A01 | • | • | • |
| anodizado plata mate A02 | • | • | • |
| anodizado inox mate A12 | • | • | • |
| blanco chamonix AM1 | • | • | • |
| black mokka AM9 | • | • | • |

caja interior autoventa de 1 kit
* embalaje exterior de 4 kits

Lacado Blanco A01
RAL 9110 Brillante

Anodizado Plata Mate A02
Mate

Anodizado Inox Mate A12
Mate

Lacado Blanco Chamonix AM1
RAL 9003 Mate texturizado

Lacado Black Mokka AM9
RAL 9005 Mate texturizado

KIT "H" PRH 16-12 2+2

Kit de 2 perfiles japonesa "H" (2 tiras de 2 m)

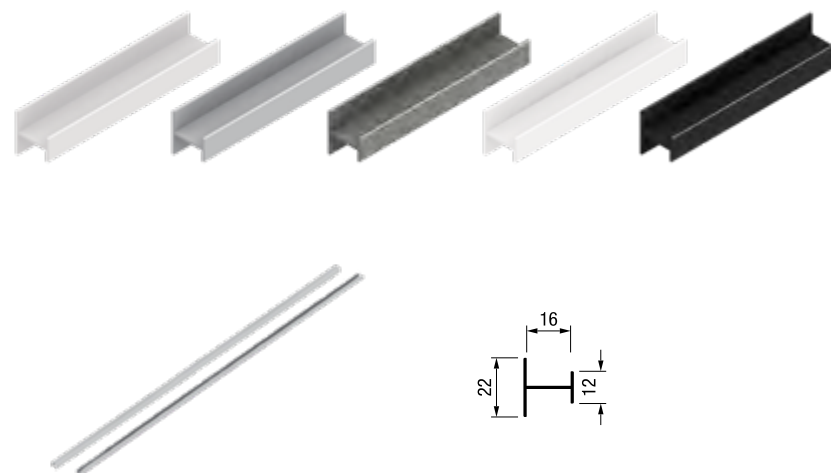

composición del kit de japonesas "H":

- 2 tiras de 2 m.

cod. **3KH528*****

| acabados *** | |
|--------------------------|---|
| lacado blanco A01 | • |
| anodizado plata mate A02 | • |
| anodizado inox mate A12 | • |
| blanco chamonix AM1 | • |
| black mokka AM9 | • |

KIT PUERTA KP-TR16MIN85

Kit de 1 puerta de hasta 2,6m x 1m
para tablero de 16 mm y carriles de 85 mm

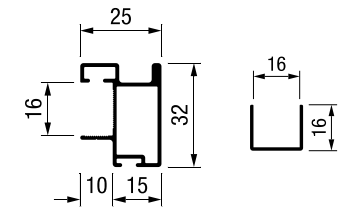
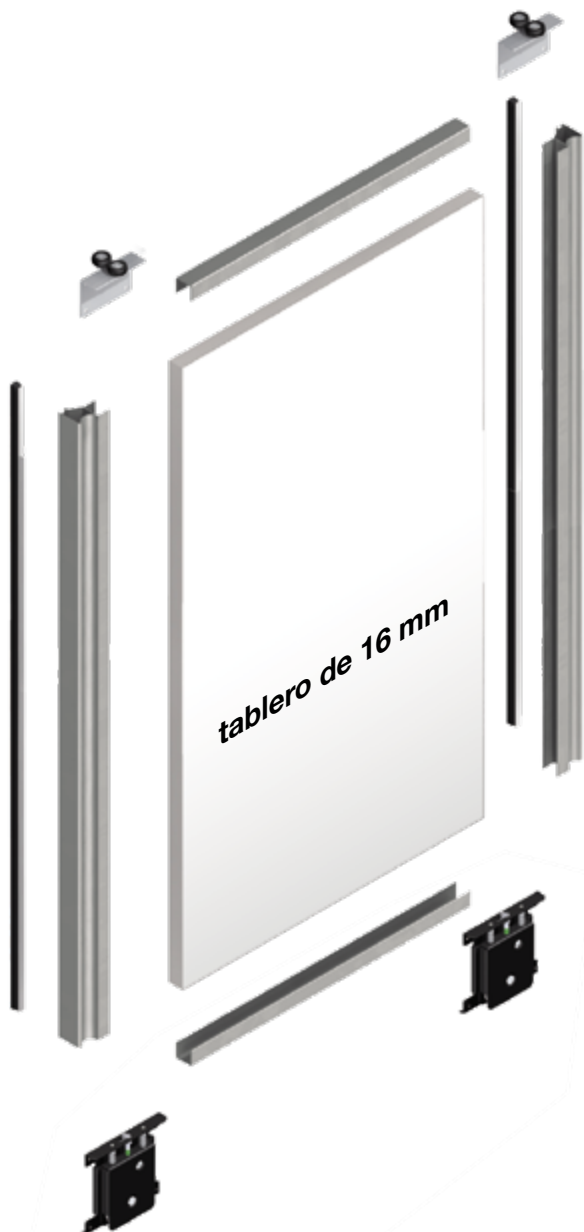

cod. **75M000*****

| acabados | *** |
|----------------------|-----|
| lacado blanco | A01 |
| anodizado plata mate | A02 |
| anodizado inox mate | A12 |
| blanco chamonix | AM1 |
| black mokka | AM9 |

caja interior autoventa de 1 kit
* embalaje exterior de 4 kits (tablero no incluido)

composición del kit de puerta:

- 2 ruedas inferiores
- 2 ruedas superiores
- 2 perfiles tiradores (2 x 2,6 m)
- 1 perfil horizontal (superior / inferior) (1 x 2 m)
- tornillería varia
- cepillo

*tablero no incluido

Lacado Blanco A01

RAL 9110 Brillante

Anodizado Plata Mate A02

Mate

Anodizado Inox Mate A12

Mate

Lacado Blanco Chamonix AM1

RAL 9003 Mate texturizado

Lacado Black Mokka AM9

RAL 9005 Mate texturizado

KIT GUÍAS KG85

Kit de 1 guía alta, 1 guía baja de 85 mm y piezas de fijación
Medidas de 2-3-4 m

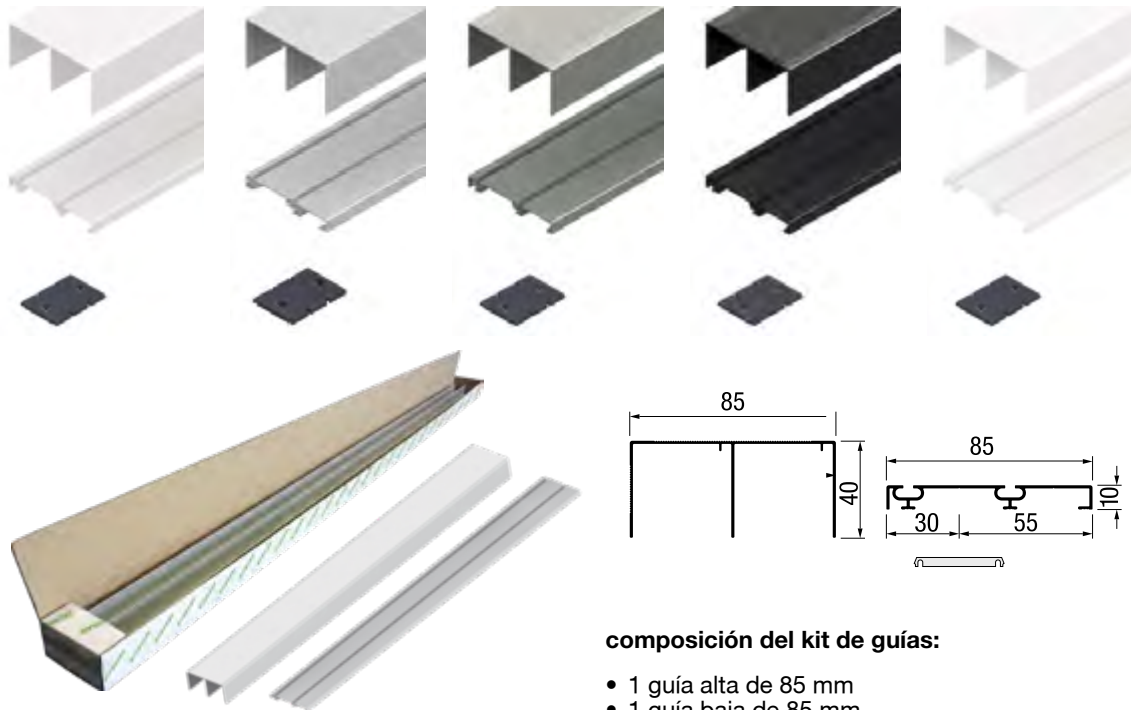

composición del kit de guías:

- 1 guía alta de 85 mm
- 1 guía baja de 85 mm
- Piezas de anclaje carril bajo

| cod. | 712***200 kit 2m | 712***300 kit 3m | 712***400 kit 4m |
|--------------------------|---------------------|---------------------|---------------------|
| acabados *** | | | |
| lacado blanco A01 | • | • | • |
| anodizado plata mate A02 | • | • | • |
| anodizado inox mate A12 | • | • | • |
| blanco chamonix AM1 | • | • | • |
| black mokka AM9 | • | • | • |

caja interior autoventa de 1 kit
* embalaje exterior de 4 kits

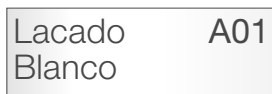

RAL 9110 Brillante



Mate



Mate

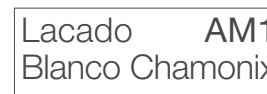

RAL 9003 Mate texturizado

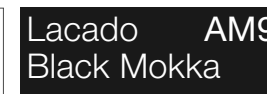

RAL 9005 Mate texturizado

KIT "H" PRH 16-12 2+2

Kit de 2 perfiles japonesa "H" (2 tiras de 2 m)

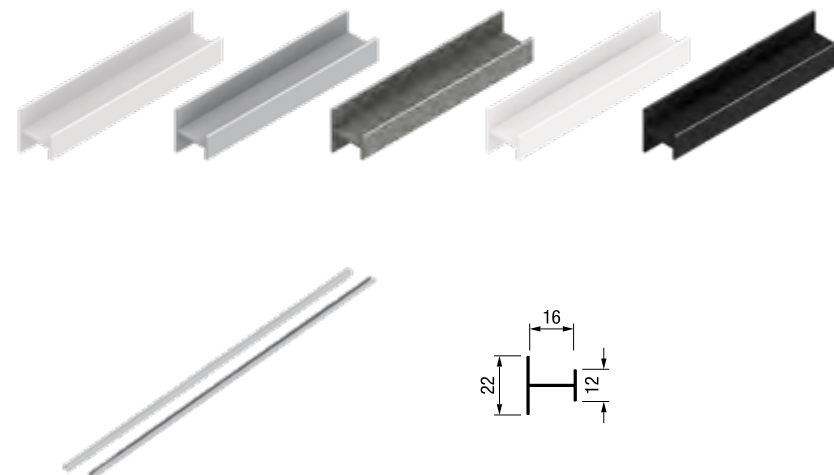

composición del kit de japonesas "H":

- 2 tiras de 2 m.

cod. **3KH528*****

| acabados *** | |
|--------------------------|---|
| lacado blanco A01 | • |
| anodizado plata mate A02 | • |
| anodizado inox mate A12 | • |
| blanco chamonix AM1 | • |
| black mokka AM9 | • |

KIT PUERTA KP-TR19MIN85

Kit de 1 puerta de hasta 2,6m x 1m
para tablero de 19 mm y carriles de 85 mm

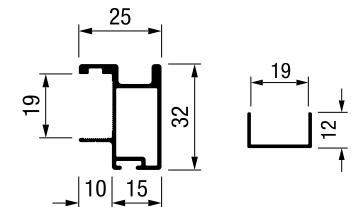
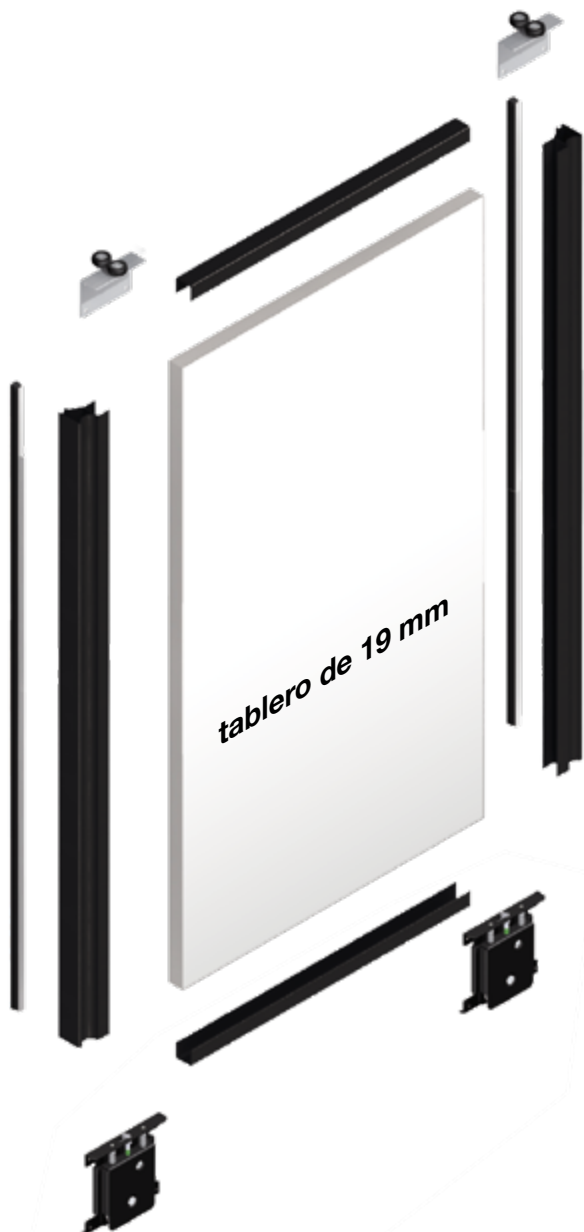

tablero de 19 mm

cod. **76000*****

| acabados | *** |
|----------------------|-----|
| lacado blanco | A01 |
| anodizado plata mate | A02 |
| anodizado inox mate | A12 |
| blanco chamonix | AM1 |
| black mokka | AM9 |

caja interior autoventa de 1 kit
* embalaje exterior de 4 kits (tablero no incluido)

composición del kit de puerta:

- 2 ruedas inferiores
- 2 ruedas superiores
- 2 perfiles tiradores (2 x 2,6 m)
- 1 perfil horizontal (superior / inferior) (1 x 2 m)
- tornillería varia
- cepillo

*tablero no incluido

Lacado Blanco A01

RAL 9110 Brillante

Anodizado Plata Mate A02

Mate

Anodizado Inox Mate A12

Mate

Lacado Blanco Chamonix AM1

RAL 9003 Mate texturizado

Lacado Black Mokka AM9

RAL 9005 Mate texturizado

KIT GUÍAS KG85

Kit de 1 guía alta, 1 guía baja de 85 mm y piezas de fijación
Medidas de 2-3-4 m

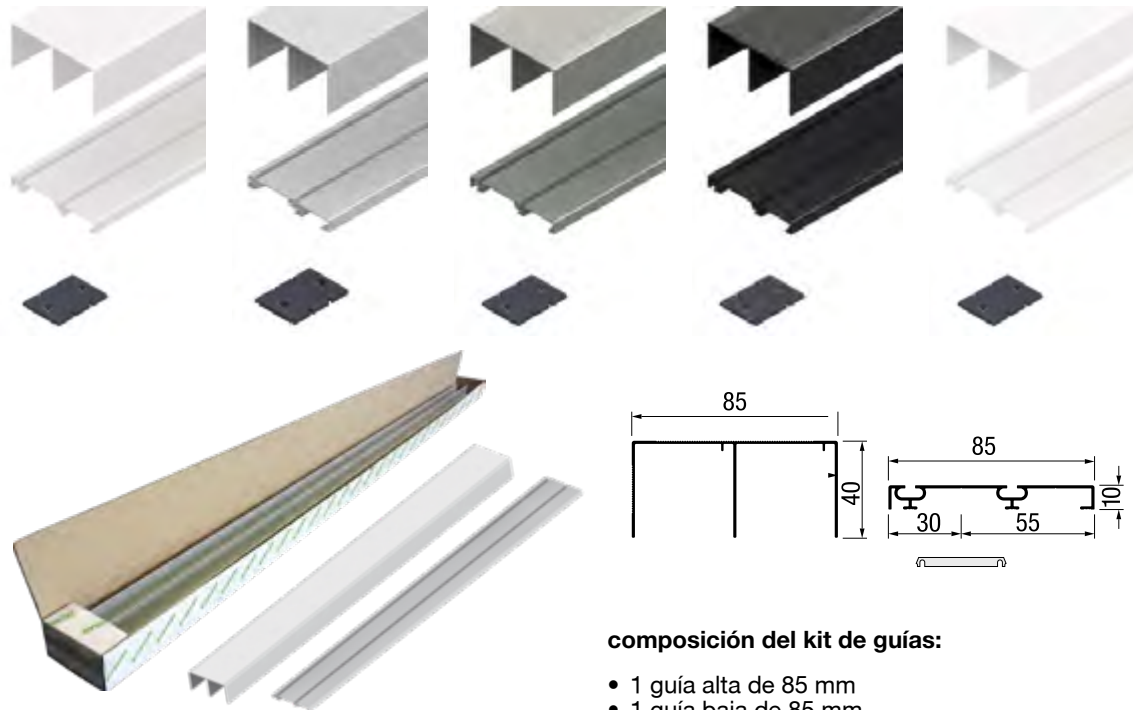

composición del kit de guías:

- 1 guía alta de 85 mm
- 1 guía baja de 85 mm
- Piezas de anclaje carril bajo

| cod. | 712***200 kit 2m | 712***300 kit 3m | 712***400 kit 4m |
|---------------------------------|---------------------|---------------------|---------------------|
| acabados *** | | | |
| lacado blanco A01 | • | • | • |
| anodizado plata mate A02 | • | • | • |
| anodizado inox mate A12 | • | • | • |
| blanco chamonix AM1 | • | • | • |
| black mokka AM9 | • | • | • |

caja interior autoventa de 1 kit
* embalaje exterior de 4 kits

Lacado Blanco **A01**

RAL 9110 Brillante

Anodizado Plata Mate **A02**

Mate

Anodizado Inox Mate **A12**

Mate

Lacado Blanco Chamonix **AM1**

RAL 9003 Mate texturizado

Lacado Black Mokka **AM9**

RAL 9005 Mate texturizado

KIT "H" PRH 19 - S85 2+2

Kit de 2 perfiles japonesa "H" (2 tiras de 2 m)

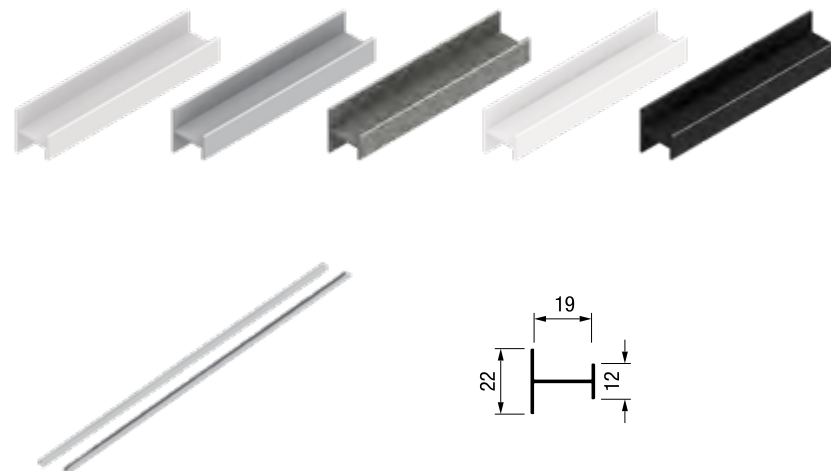

composición del kit de japonesas "H":

- 2 tiras de 2 m.

cod. **3KH521*****

| acabados *** | |
|---------------------------------|---|
| lacado blanco A01 | • |
| anodizado plata mate A02 | • |
| anodizado inox mate A12 | • |
| blanco chamonix AM1 | • |
| black mokka AM9 | • |

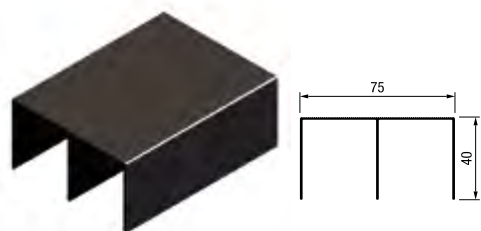

CARRIL ALTO CAA75

| | | |
|-------------|-----------------|------------------|
| | tira de 4m | tira de 6m |
| cod. | 110400** | 110600*** |

| acabados *** | | |
|---------------------------------|---|---|
| lacado blanco A01 | • | • |
| anodizado plata mate A02 | • | • |
| anodizado inox mate A12 | • | • |
| blanco chamonix AM1 | • | • |
| black mokka AM9 | • | • |

caja 8 tiras caja 8 tiras

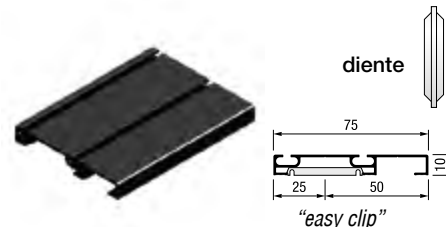

CARRIL BAJO-DIENTE CBD75

| | | |
|-------------|------------------|------------------|
| | tira de 4m | tira de 6m |
| cod. | 112400*** | 112600*** |

| acabados *** | | |
|---------------------------------|---|---|
| lacado blanco A01 | • | • |
| anodizado plata mate A02 | • | • |
| anodizado inox mate A12 | • | • |
| blanco chamonix AM1 | • | • |
| black mokka AM9 | • | • |

paquete 8 tiras paquete 8 tiras

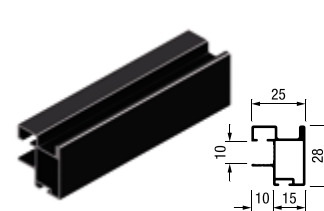

TIRADOR TR10 MIN

| | |
|-------------|------------------|
| | tira de 2,6m |
| cod. | 14M260*** |

| acabados *** | |
|---------------------------------|---|
| lacado blanco A01 | • |
| anodizado plata mate A02 | • |
| anodizado inox mate A12 | • |
| blanco chamonix AM1 | • |
| black mokka AM9 | • |

caja 20 tiras

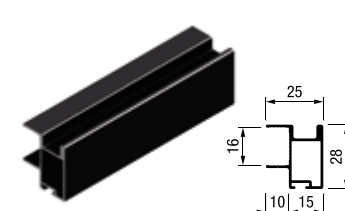

TIRADOR TR16 MIN

| | |
|-------------|------------------|
| | tira de 2,6m |
| cod. | 15M260*** |

| acabados *** | |
|---------------------------------|---|
| lacado blanco A01 | • |
| anodizado plata mate A02 | • |
| anodizado inox mate A12 | • |
| blanco chamonix AM1 | • |
| black mokka AM9 | • |

caja 20 tiras



PERFIL REMATE PRU10-V

| | |
|-------------|------------------|
| | tira de 4m |
| cod. | 121400*** |

| acabados *** | |
|---------------------------------|---|
| lacado blanco A01 | • |
| anodizado plata mate A02 | • |
| anodizado inox mate A12 | • |
| blanco chamonix AM1 | • |
| black mokka AM9 | • |

paquete 10 tiras

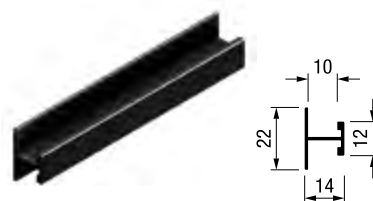

PERFIL "H" PRH10-V

| | |
|-------------|------------------|
| | tira de 4m |
| cod. | 127400*** |

| acabados *** | |
|---------------------------------|---|
| lacado blanco A01 | • |
| anodizado plata mate A02 | • |
| anodizado inox mate A12 | • |
| blanco chamonix AM1 | • |
| black mokka AM9 | • |

paquete 10 tiras



PERFIL REMATE PRU16

| | |
|-------------|------------------|
| | tira de 4m |
| cod. | 121400*** |

| acabados *** | |
|---------------------------------|---|
| lacado blanco A01 | • |
| anodizado plata mate A02 | • |
| anodizado inox mate A12 | • |
| blanco chamonix AM1 | • |
| black mokka AM9 | • |

paquete 10 tiras

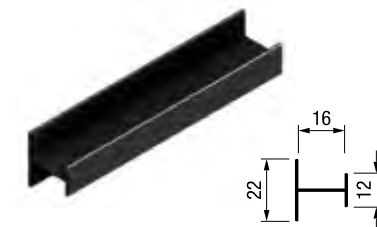

PERFIL "H" PRH16-12

| | |
|-------------|------------------|
| | tira de 4m |
| cod. | 528400*** |

| acabados *** | |
|---------------------------------|---|
| lacado blanco A01 | • |
| anodizado plata mate A02 | • |
| anodizado inox mate A12 | • |
| blanco chamonix AM1 | • |
| black mokka AM9 | • |

paquete 10 tiras

* NOTA IMPORTANTE: Embalaje industria - pedido mínimo, la perfilería de aluminio será suministrada por caja en la cantidad mínima indicada.

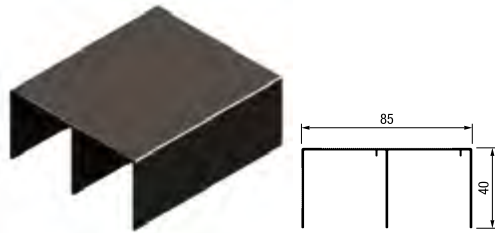

CARRIL ALTO CAA85

| | | |
|-------------|-----------------|------------------|
| | tira de 4m | tira de 6m |
| cod. | 510400** | 510600*** |

| acabados *** | | |
|---------------------------------|--------------|--------------|
| lacado blanco A01 | • | • |
| anodizado plata mate A02 | • | • |
| anodizado inox mate A12 | • | • |
| blanco chamonix AM1 | • | • |
| black mokka AM9 | • | • |
| | caja 8 tiras | caja 8 tiras |

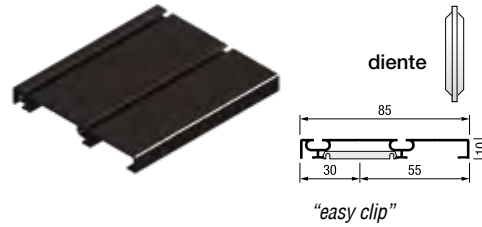

CARRIL BAJO-DIENTE CBD85-10

| | | |
|-------------|------------------|------------------|
| | tira de 4m | tira de 6m |
| cod. | 513400*** | 513600*** |

| | |
|-----------------|-----------------|
| • | • |
| • | • |
| • | • |
| • | • |
| • | • |
| paquete 8 tiras | paquete 8 tiras |

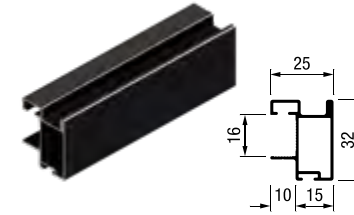

TIRADOR TR16 MIN-S85

| | |
|-------------|------------------|
| | tira de 2,6m |
| cod. | 55M260*** |

| |
|---------------|
| • |
| • |
| • |
| • |
| • |
| caja 20 tiras |

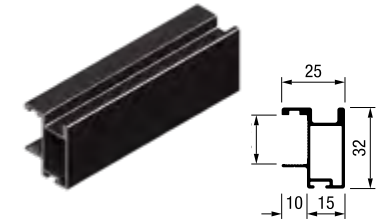

TIRADOR TR19-S85

| | |
|-------------|------------------|
| | tira de 2,6m |
| cod. | 560260*** |

| |
|---------------|
| • |
| • |
| • |
| • |
| • |
| caja 20 tiras |

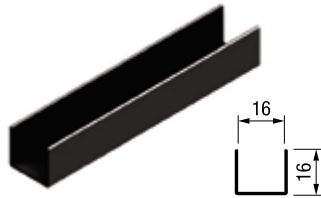

PERFIL REMATE PRU16

| | |
|-------------|-----------------|
| | tira de 4m |
| cod. | 121400** |

| acabados *** | |
|---------------------------------|------------------|
| lacado blanco A01 | • |
| anodizado plata mate A02 | • |
| anodizado inox mate A12 | • |
| blanco chamonix AM1 | • |
| black mokka AM9 | • |
| | paquete 10 tiras |

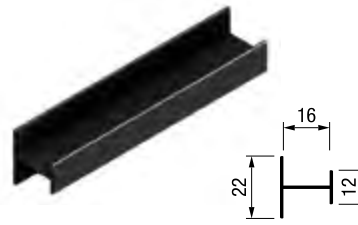

PERFIL "H" PRH16-12

| | |
|-------------|------------------|
| | tira de 4m |
| cod. | 528400*** |

| |
|------------------|
| • |
| • |
| • |
| • |
| • |
| paquete 10 tiras |



PERFIL REMATE PRU19-S85

| | |
|-------------|------------------|
| | tira de 4m |
| cod. | 520400*** |

| |
|------------------|
| • |
| • |
| • |
| • |
| • |
| paquete 10 tiras |

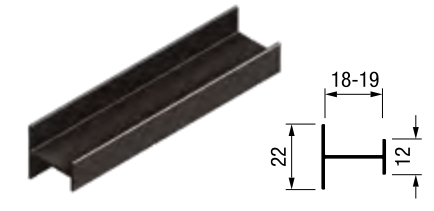

PERFIL "H" PRH19-S85

| | |
|-------------|------------------|
| | tira de 4m |
| cod. | 521400*** |

| |
|------------------|
| • |
| • |
| • |
| • |
| • |
| paquete 10 tiras |

* NOTA IMPORTANTE: Embalaje industria - pedido mínimo, la perfilería de aluminio será suministrada por caja en la cantidad mínima indicada.

Economía de montaje, seguridad y ajuste máximos

easy soft
registered patent



SYSKOR
aluminium systems



easy soft
patente registrada

El innovador sistema de apertura y cierre amortiguado “Easy Soft” Terra de Syskor permite la fabricación de armarios empotrados de altas prestaciones con una extraordinaria **suavidad de funcionamiento** incluso para puertas de **hasta 40 Kg de peso**.

Este revolucionario diseño de **amortiguación integrado en la rueda superior** facilita y ahorra tiempo de montaje posicionando automáticamente el sistema de frenado y **garantizando su perfecto ajuste**.

EMBALAJE KIT

KIT 2 RUEDAS ALTAS CON CIERRE AMORTIGUADO PARA PUERTA CORREDERA TERRA S75

| | peso por puerta | |
|---------------------------------|------------------|---|
| medio cod. 104S75ES2 | hasta 25 Kg | • |
| fuerte cod. 104S75ES3 | de 25 Kg a 40 Kg | • |

KIT 2 RUEDAS ALTAS CON CIERRE AMORTIGUADO PARA PUERTA CORREDERA TERRA S85

| | peso por puerta | |
|---------------------------------|------------------|---|
| medio cod. 104S85ES2 | hasta 25 Kg | • |
| fuerte cod. 104S85ES3 | de 25 Kg a 40 Kg | • |

composición del kit de ruedas superiores easy soft:

- 2 ruedas superiores con amortiguación integrada
- 2 activadores
- Tornillería varia

Cajas de 20 kits





EMBALAJE KIT

**KIT 2 RUEDAS ALTAS + 2 RUEDAS BAJAS
PUERTA CORREDERA TERRA S75**

código **100S75N00**

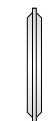

diente

**KIT 2 RUEDAS ALTAS + 2 RUEDAS BAJAS
PUERTA CORREDERA TERRA S85**

código **100S85N00**

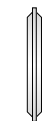

diente

composición del kit de ruedas:

- 2 ruedas inferiores diente
 - 2 ruedas superiores
 - Tornillería varia
- Caja de 30 kits

RUEDAS SUPERIORES

**RUEDA SUPERIOR
RODAMIENTO S75**

código **102R0DS75**



zincado plata

EMBALAJE INDUSTRIA

bolsa de 25 unidades
caja de 200 unidades

**RUEDA SUPERIOR
RODAMIENTO S85**

código **102R0DS85**



zincado plata

bolsa de 25 unidades
caja de 200 unidades

**RUEDA SUPERIOR
ANTIVUELCO**

código **802ANV000**



zincado plata

caja de 100 unidades

RUEDAS INFERIORES

**RUEDA INFERIOR
Ø60 DIENTE NEGRA**

código **101D60002**



zincado negro

EMBALAJE INDUSTRIA

caja de 50 unidades

**S75
S85**



diente

**GOMA TR10
CRISTAL 4 mm**

código **104GOMTRA**



PVC transparente



ancho de 6 mm
cristal 4 / perfil 10 mm
rollo 100 m

**GOMA TR10
CRISTAL 5 mm**

código **104GOM014**



PVC transparente

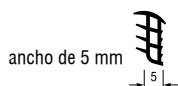

ancho de 5 mm
cristal 5 / perfil 10 mm
rollo 100 m

**GOMA TR10
CRISTAL 6 mm**

código **804004000**



PVC transparente

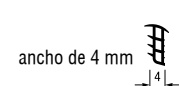

ancho de 4 mm
cristal 6 / perfil 10 mm
rollo 100 m

**GOMA TR10
CRISTAL 8 mm**

código **804002000**



PVC transparente

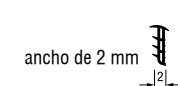

ancho de 2 mm
cristal 8 / perfil 10 mm
rollo 200 m

**GOMA TR16
CRISTAL 4 mm**

código **104GOMTR16**



PVC transparente



ancho de 12 mm
cristal 4 / perfil 16 mm
rollo 50 m

**GOMA TR19
CRISTAL 4 mm**

código **104GOMTR19**



PVC transparente



ancho de 15 mm
cristal 4
perfil 19 y 18 mm
caja de 1 rollo de 50m

**TORNILLO R/CHAPA
3,5X6,5**

código **1000000001**



zincado plata

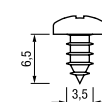

caja de 1.000 unidades

**CEPILLO TRASERO
10 mm**

código
blanco **103100001**
negro **103100002**



tiradores TR (trasera)



bobinas 300 m

**PAPEL ADHESIVO
NEGRO 45 cm**

código **104ADH002**



papel adhesivo negro

rollo 20 m

**ESCUADRA PLANA
40X10**

código **100000003**



zincado plata

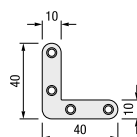

caja de 100 unidades

**PLETINA UNIÓN
JAPONESA**

código **800000004**



zincado plata

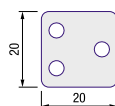

caja de 100 unidades

**FRENO CARRIL
BAJO ZAMAK**

código **104FRE000**



bolsa de 50 unidades
válido para:
CBD50
CBD75
CBD85
CBE16

**HERRAJE ANCLAJE
CARRIL BAJO**

código **104ANC000**



plástico gris
válido para:
CBD75
CBD85
CBD60

bolsa de 50 unidades
caja de 20 bolsas

SYSKOR

aluminium systems



Foto: Armario de tres puertas correderas sistema Terra de Syskor en aluminio anodizado

Sistema S75 para tablero de 10mm y 16mm

Sistema S85 para tablero de 16mm y 19mm

Sistema S80 para tablero de 16mm

Sistema Basic para tablero de 10mm y 16mm

cada caja contiene todo lo necesario para el montaje de una puerta corredera



composición del kit de puerta:

- 2 ruedas inferiores
 - 2 ruedas superiores
 - tornillería varia
 - cepillo
 - 2 perfiles tiradores (2 x 2,6 m)
 - 1 perfil horizontal (superior / inferior) (1 x 2 m)
- *tablero no incluido

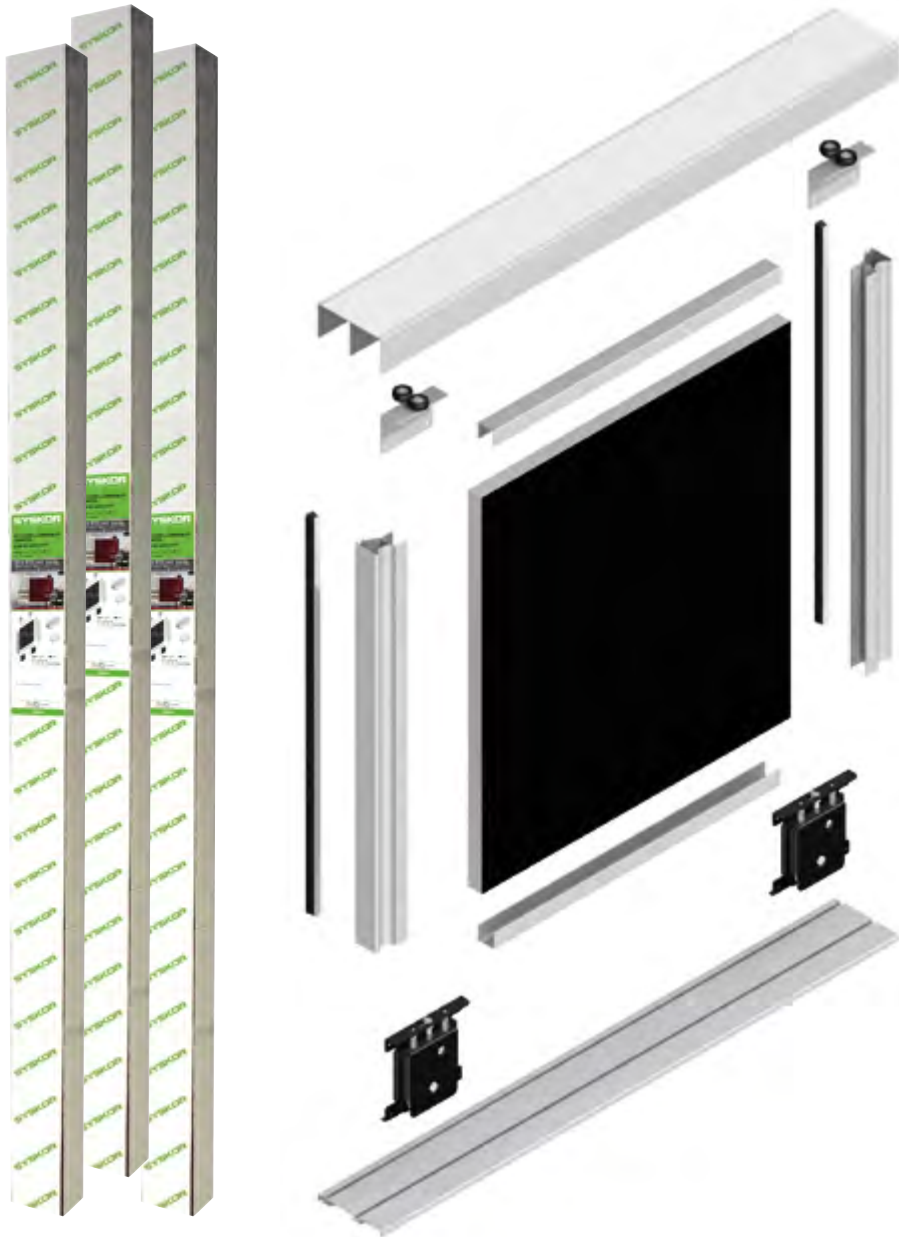

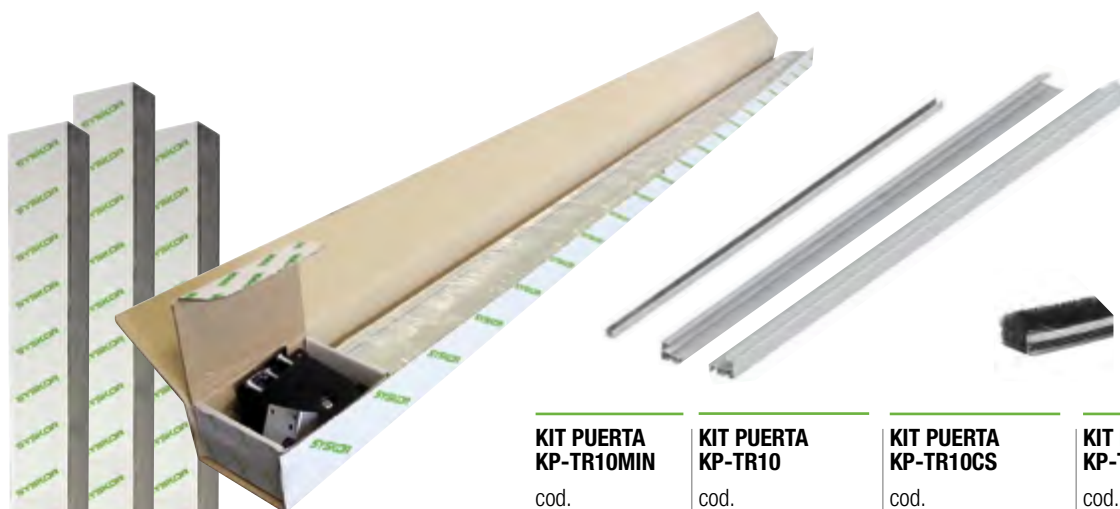

composición del kit de puerta:

- 2 ruedas inferiores
- 2 ruedas superiores
- tornillería varia
- cepillo
- 2 perfiles tiradores (2 x 2,6 m)
- 1 perfil horizontal (superior / inferior) (1 x 2 m)

*tablero no incluido



**KITS DE PUERTA
SERIE CLASSIC
S75 - 10 mm**

| | KIT PUERTA KP-TR10MIN cod. 34M000*** | KIT PUERTA KP-TR10 cod. 340000*** | KIT PUERTA KP-TR10CS cod. 360000*** | KIT PUERTA KP-TR10KB cod. 361000*** | KIT PUERTA KP-TR10ML cod. 341000*** | KIT PUERTA KP-TR10RD cod. 342000*** | KIT PUERTA KP-TR10DC cod. 362000*** | KIT PUERTA KP-TR10ND cod. 363000*** |
|---|---|--|---|---|---|---|---|---|
|  2,6 m |  2,6 m |  2,6 m |  2,6 m |  2,6 m |  2,6 m |  2,6 m |  2,6 m |  2,6 m |
|  |  |  |  |  |  |  |  |  |

| acabados *** | | | | | | | | |
|----------------------------------|---|---|---|---|---|---|---|---|
| acabado aluminio | | | | | | | | |
| lacado blanco A01 | • | | • | | | • | | |
| plata mate A02 | • | | • | | • | | • | • |
| oro mate repulido A03 | | | • | | | | | |
| bronce mate repulido A04 | | | • | | | | | |
| oro brillo repulido A10 | | | • | | | | | |
| lacado inox A11 | | | • | | | | | |
| chapa sin barnizar | | | | | | | | |
| roble s/b C01 | • | • | • | • | • | • | • | • |
| sapelly s/b C02 | • | • | • | • | • | • | • | • |
| fresno s/b C03 | | • | • | • | • | • | • | • |
| cerezo s/b C04 | • | • | • | • | • | • | • | • |
| haya s/b C05 | • | • | • | • | • | • | • | • |
| pino s/b C06 | • | • | • | • | • | • | • | • |
| haya vaporizada s/b C07 | • | • | • | • | • | • | • | • |
| papel melamina | | | | | | | | |
| roble claro A-412 P02 | | • | • | • | • | • | • | • |
| sapelly D-468 P03 | | • | • | • | • | • | • | • |
| pino C-419 P04 | | • | • | • | • | • | • | • |
| cerezo H-450 P05 | | • | • | • | • | • | • | • |
| haya vaporizada H-428 P06 | • | • | • | • | • | • | • | • |
| roble oscuro A-725 P07 | • | • | • | • | • | • | • | • |
| cerezo tajo H-2428 P08 | • | • | • | • | • | • | • | • |
| wengue congo D-0427 P09 | • | • | • | • | • | • | • | • |

Caja interior autoventa de 1 kit. * Embalaje exterior de 4 kits



composición del kit de puerta:

- 2 ruedas inferiores
- 2 ruedas superiores
- tornillería varia
- cepillo
- 2 perfiles tiradores (2 x 2,6 m)
- 1 perfil horizontal (superior / inferior) (1 x 2 m)
- *tablero no incluido



KP-TR10V1

código 343000***



KP-TR10V2

código 344000***

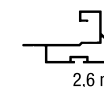

KP-TR10V7

código 365000***

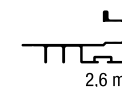

| acabados *** | | | |
|---------------------------|---|---|---|
| acabado aluminio | | | |
| lacado blanco A01 | | | • |
| plata mate A02 | • | | • |
| chapa sin barnizar | | | |
| roble s/b C01 | • | • | • |
| sapelly s/b C02 | • | • | • |
| fresno s/b C03 | • | • | • |
| cerezo s/b C04 | • | • | • |
| haya s/b C05 | • | • | • |
| pino s/b C06 | • | • | • |
| haya vaporizada s/b C07 | • | • | • |
| papel melamina | | | |
| roble claro A-412 P02 | • | • | • |
| sapelly D-468 P03 | • | • | • |
| pino C-419 P04 | • | • | • |
| cerezo H-450 P05 | • | • | • |
| haya vaporizada H-428 P06 | • | • | • |
| roble oscuro A-725 P07 | • | • | • |
| cerezo tajo H-2428 P08 | • | • | • |
| wengue congo D-0427 P09 | • | • | • |

Caja interior autoventa de 1 kit

* Embalaje exterior de 4 kits



composición del kit de puerta:

- 2 ruedas inferiores
- 2 ruedas superiores
- tornillería varia
- cepillo
- 2 perfiles tiradores (2 x 2,6 m)
- 1 perfil horizontal (superior / inferior) (1 x 2 m)
- *tablero no incluido



**KITS DE PUERTA
SERIE CLASSIC
S75 - 16 mm**

| KIT PUERTA KP-TR16MIN cod. 35M000*** | KP-TR16 cod. 350D60*** | KP-TR16ML cod. 351000*** | KP-TR16RD cod. 352000*** |
|--|---------------------------|-----------------------------|-----------------------------|
| | | | |

| acabados *** | | | | |
|---------------------------|---|---|---|---|
| acabado aluminio | | | | |
| lacado blanco A01 | • | • | • | • |
| plata mate A02 | • | • | • | • |
| oro mate repulido A03 | • | • | • | • |
| bronce mate repulido A04 | • | • | • | • |
| oro brillo repulido A10 | • | • | • | • |
| lacado inox A11 | • | • | • | • |
| chapa sin barnizar | | | | |
| roble s/b C01 | • | • | • | • |
| sapelly s/b C02 | • | • | • | • |
| fresno s/b C03 | • | • | • | • |
| cerezo s/b C04 | • | • | • | • |
| haya s/b C05 | • | • | • | • |
| pino s/b C06 | • | • | • | • |
| haya vaporizada s/b C07 | • | • | • | • |
| papel melamina | | | | |
| roble claro A-412 P02 | • | • | • | • |
| sapelly D-468 P03 | • | • | • | • |
| pino C-419 P04 | • | • | • | • |
| cerezo H-450 P05 | • | • | • | • |
| haya vaporizada H-428 P06 | • | • | • | • |
| roble oscuro A-725 P07 | • | • | • | • |
| cerezo tajo H-2428 P08 | • | • | • | • |
| wengue congo D-0427 P09 | • | • | • | • |
| blanco W-402 P84 | • | • | • | • |

Caja interior autoventa de 1 kit

* Embalaje exterior de 4 kits

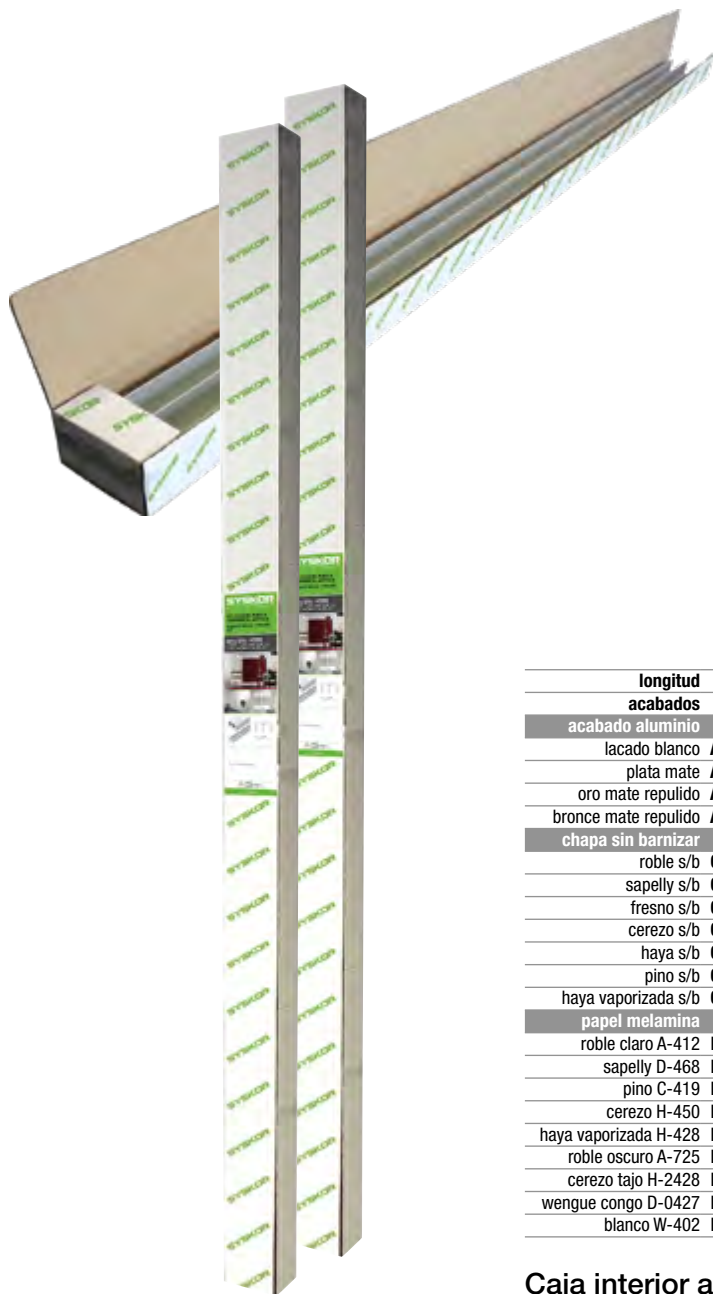

| | KG50-20 | KG50-30 | KG50-40 | KG75-20 | KG75-30 | KG75-40 |
|----------------------------------|-----------|-----------|-----------|-----------|-----------|-----------|
| cod. | 310***200 | 310***300 | 310***400 | 312***200 | 312***300 | 312***400 |
| | | | | | | |
| | | | | | | |
| longitud | 2 m | 3 m | 4 m | 2 m | 3 m | 4 m |
| acabados *** | | | | €/kit | €/kit | €/kit |
| acabado aluminio | | | | | | |
| lacado blanco A01 | • | • | • | • | • | • |
| plata mate A02 | • | • | • | • | • | • |
| oro mate repulido A03 | • | • | • | • | • | • |
| bronce mate repulido A04 | • | • | • | • | • | • |
| chapa sin barnizar | | | | | | |
| roble s/b C01 | | | | • | • | • |
| sapelly s/b C02 | | | | • | • | • |
| fresno s/b C03 | | | | • | • | • |
| cerezo s/b C04 | | | | • | • | • |
| haya s/b C05 | | | | • | • | • |
| pino s/b C06 | | | | • | • | • |
| haya vaporizada s/b C07 | | | | • | • | • |
| papel melamina | | | | | | |
| roble claro A-412 P02 | | | | • | • | • |
| sapelly D-468 P03 | | | | • | • | • |
| pino C-419 P04 | | | | • | • | • |
| cerezo H-450 P05 | | | | • | • | • |
| haya vaporizada H-428 P06 | | | | • | • | • |
| roble oscuro A-725 P07 | | | | • | • | • |
| cerezo tajo H-2428 P08 | | | | • | • | • |
| wengue congo D-0427 P09 | | | | • | • | • |
| blanco W-402 P84 | | | | • | • | • |

Caja interior autoventa de 1 kit

* Embalaje exterior de 4 kits

SYSKOR

aluminium systems



Foto: Armario de tres puertas correderas sistema Terra de Syskor en aluminio anodizado

kits de guías de tres carriles para puerta corredera apoyada **terra classic**
embalaje kit de guías - carril alto 75 mm **program**



KG75-3G 20

cod. **308A02200**

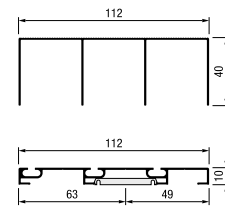
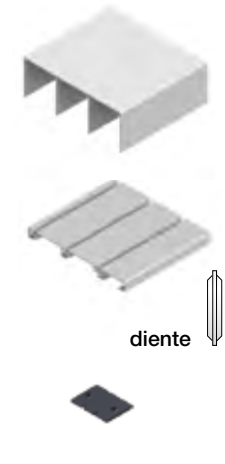

longitud 2 m
acabado plata mate
cod. **308A02200**

KG75-3G 30

cod. **308A02300**

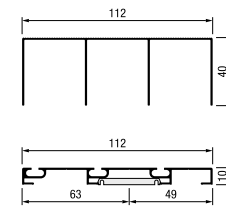
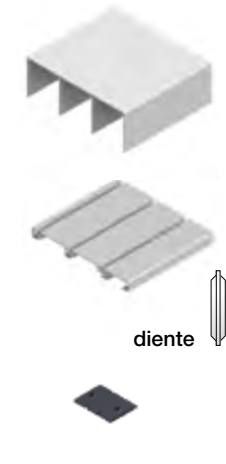

longitud 3 m
acabado plata mate
cod. **308A02300**

KG75-3G 40

cod. **308A02400**

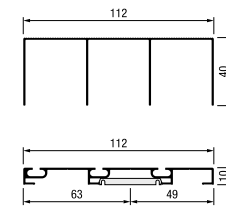
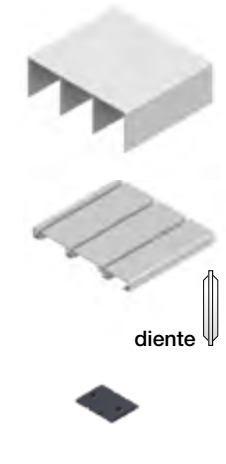

longitud 4 m
acabado plata mate
cod. **308A02400**

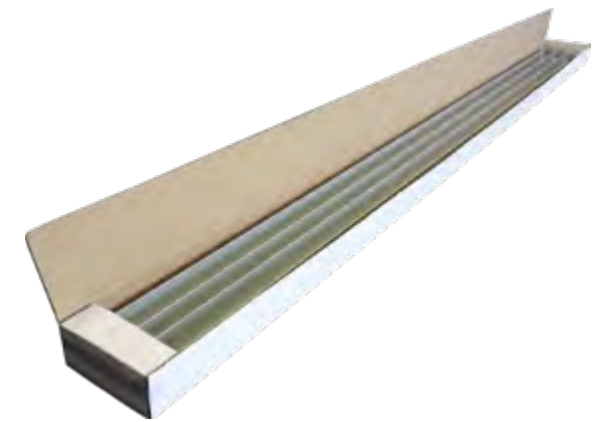

Caja interior autoventa de 1 kit

composición del kit
de perfiles "U":

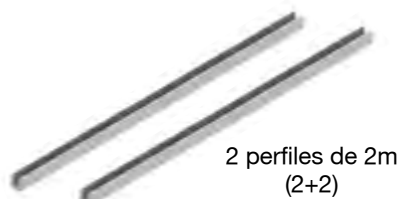

Caja interior autoventa de 1 kit

**KITS
PERFILES
"U"
2+2**

**KIT "U" PRU 10
2+2**
cod.
3KU120***



**KIT "U" PRU 10V
2+2**
cod.
3KU126***

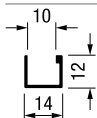

**KIT "U" PRU 16
2+2**
cod.
3KU121***



**KIT "U" PRU 16V S85
2+2**
cod.
3KU526***

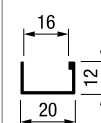

**KIT "U" PRU 19 S85
2+2**
cod.
3KU520***

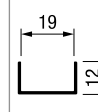

acabados ***

| | | | | | |
|---------------------------|------------|---|---|---|---|
| acabado aluminio | | | | | |
| lacado blanco | A01 | • | • | • | • |
| plata mate | A02 | • | • | • | • |
| oro mate repulido | A03 | • | • | • | • |
| bronce mate repulido | A04 | • | • | • | • |
| oro brillo repulido | A10 | • | • | • | • |
| lacado inox | A11 | • | • | • | • |
| chapa sin barnizar | | | | | |
| roble s/b | C01 | • | • | • | • |
| sapelly s/b | C02 | • | • | • | • |
| fresno s/b | C03 | • | • | • | • |
| cerezo s/b | C04 | • | • | • | • |
| haya s/b | C05 | • | • | • | • |
| pino gallego s/b | C06 | • | • | • | • |
| haya vaporizada s/b | C07 | • | • | • | • |
| papel melamina | | | | | |
| roble claro A-412 | P02 | • | • | • | • |
| sapelly D-468 | P03 | • | • | • | • |
| pino melis C-419 | P04 | • | • | • | • |
| cerezo H-450 | P05 | • | • | • | • |
| haya vap -428-B-2 | P06 | • | • | • | • |
| roble oscuro A-725 | P07 | • | • | • | • |
| cerezo tajío H-2428 | P08 | • | • | • | • |
| wengue congo D-0427 | P09 | • | • | • | • |
| blanco W-402 | P84 | • | • | • | • |

composición del kit de perfiles "H":

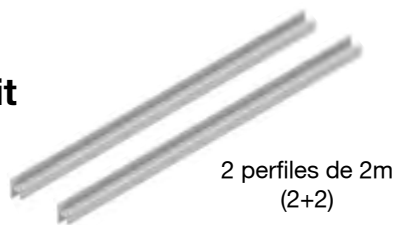

Caja interior autoventa de 1 kit

KITS PERFILES "H" 2+2

KIT "H" PRH 10 2+2
cod.
3KH122***

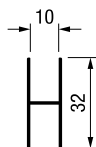

KIT "H" PRH 10-25 2+2
cod.
3KH128***

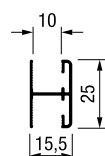

KIT "H" PRH 10V 2+2
cod.
3KH127***

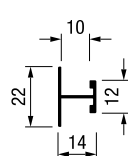

KIT "H" PRH 16 2+2
cod.
3KH123***

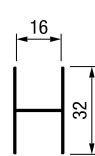

KIT "H" PRH 16-12 2+2
cod.
3KH528***

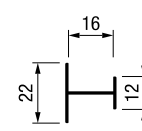

KIT "H" PRH 19 - S85 2+2
cod.
3KH521***

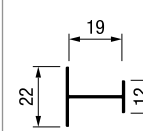

acabados ***

| | | | | | | |
|---------------------------------|---|--|---|--|---|---|
| acabado aluminio | | | | | | |
| lacado blanco A01 | • | | • | | • | • |
| plata mate A02 | • | | • | | • | • |
| oro mate repulido A03 | • | | | | • | |
| bronce mate repulido A04 | • | | | | • | |
| oro brillo repulido A10 | • | | | | • | |
| lacado inox A11 | | | | | • | |
| chapa sin barnizar | | | | | | |
| roble s/b C01 | • | | • | | • | • |
| sapelly s/b C02 | • | | • | | • | • |
| fresno s/b C03 | • | | | | • | |
| cerezo s/b C04 | • | | • | | • | • |
| haya s/b C05 | • | | • | | • | • |
| pino gallego s/b C06 | • | | • | | • | • |
| haya vaporizada s/b C07 | • | | • | | • | • |
| papel melamina | | | | | | |
| roble claro A-412 P02 | • | | • | | • | • |
| sapelly D-468 P03 | • | | • | | • | • |
| pino melis C-419 P04 | • | | • | | • | • |
| cerezo H-450 P05 | • | | • | | • | • |
| haya vap -428-B-2 P06 | • | | • | | • | • |
| roble oscuro A-725 P07 | • | | • | | • | • |
| cerezo tajo H-2428 P08 | • | | • | | • | • |
| wengue congo D-0427 P09 | • | | • | | • | • |
| blanco W-402 P84 | • | | • | | • | • |

**SERIE
CLASSIC
S75**

10 mm

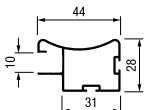
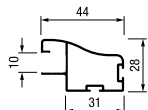
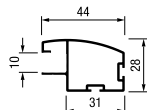
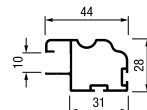
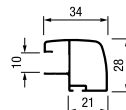
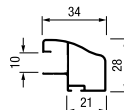
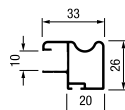
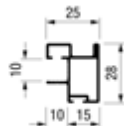

| | | | | | | | | |
|--|---------------|-------------------------|---------------|---------------|---------------|---------------|-------------------------|---------------|
| longitud | 2,6 m | 2,6 m | 2,6 m | 2,6 m | 2,6 m | 2,6 m | 2,6 m | 2,6 m |
| embalaje industria cantidad mínima* | caja 20 tiras | caja 20 tiras | caja 20 tiras | caja 20 tiras | caja 16 tiras | caja 16 tiras | caja 16 tiras | caja 16 tiras |
| acabados *** | | | | | | | | |
| acabado aluminio | | | | | | | | |
| lacado blanco A01 | • | 2,90 m cod. 140290A01 • | • | • | • | • | 2,90 m cod. 162290A01 • | • |
| plata mate A02 | • | 2,90 m cod. 140290A02 • | • | • | • | • | 2,90 m cod. 162290A02 • | • |
| oro mate repulido A03 | | | • | | | | | |
| bronce mate repulido A04 | | | • | | | | | |
| oro brillo repulido A10 | | | • | | | | | |
| chapa sin barnizar | | | | | | | | |
| roble s/b C01 | • | • | • | • | • | • | • | • |
| sapelly s/b C02 | • | • | • | • | • | • | • | • |
| fresno s/b C03 | • | • | • | • | • | • | • | • |
| cerezo s/b C04 | • | • | • | • | • | • | • | • |
| haya s/b C05 | • | • | • | • | • | • | • | • |
| pino s/b C06 | • | • | • | • | • | • | • | • |
| haya vaporizada s/b C07 | • | • | • | • | • | • | • | • |
| papel melamina | | | | | | | | |
| roble claro A-412 P02 | | • | • | • | • | • | • | • |
| sapelly D-468 P03 | | • | • | • | • | • | • | • |
| pino C-419 P04 | | • | • | • | • | • | • | • |
| cerezo H-450 P05 | | • | • | • | • | • | • | • |
| haya vaporizada H-428 P06 | • | • | • | • | • | • | • | • |
| roble oscuro A-725 P07 | • | • | • | • | • | • | • | • |
| cerezo tajo H-2428 P08 | • | • | • | • | • | • | • | • |
| wengue congo D-0427 P09 | • | • | • | • | • | • | • | • |
| blanco W-402 P84 | • | • | • | • | • | • | • | • |

* NOTA IMPORTANTE: Embalaje industria - pedido mínimo, la perfilería de aluminio será suministrada por caja en la cantidad mínima indicada.

**SERIE
CLASSIC
S75**

10 mm

**PERFIL REMATE
“U” HORIZONTAL
PRU10**

código **120400*****



**PERFIL “H”
HORIZONTAL
PRH10**

código **122400*****

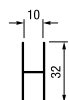

**PERFIL “H”
HORIZONTAL
PRH10-1025**

código **128400*****

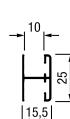







| longitud | 4 m | 4 m | 4 m |
|--|------------------|------------------|------------------|
| embalaje industria cantidad mínima* | paquete 10 tiras | paquete 10 tiras | paquete 10 tiras |
| acabados *** | | | |
| acabado aluminio | | | |
| lacado blanco A01 | • | • | • |
| plata mate A02 | • | • | • |
| oro mate repulido A03 | • | • | • |
| bronce mate repulido A04 | • | • | • |
| oro brillo repulido A10 | • | • | • |
| chapa sin barnizar | | | |
| roble s/b C01 | • | • | • |
| sapelly s/b C02 | • | • | • |
| fresno s/b C03 | • | • | • |
| cerezo s/b C04 | • | • | • |
| haya s/b C05 | • | • | • |
| pino s/b C06 | • | • | • |
| haya vaporizada s/b C07 | • | • | • |
| papel melamina | | | |
| roble claro A-412 P02 | • | • | • |
| sapelly D-468 P03 | • | • | • |
| pino C-419 P04 | • | • | • |
| cerezo H-450 P05 | • | • | • |
| haya vaporizada H-428 P06 | • | • | • |
| roble oscuro A-725 P07 | • | • | • |
| cerezo tajo H-2428 P08 | • | • | • |
| wengue congo D-0427 P09 | • | • | • |
| blanco W-402 P84 | • | • | • |

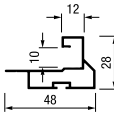
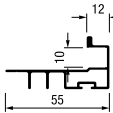

* **NOTA IMPORTANTE:** Embalaje industria - pedido mínimo, la perfilería de aluminio será suministrada por caja en la cantidad mínima indicada.

**SERIE
MINIMAL
S75**

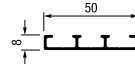
| | TIRADOR TR10V1 | TIRADOR TR10V2 | TIRADOR TR10V7 | PERFIL REMATE "U" HORIZONTAL PRU10V | PERFIL "H" HORIZONTAL PRH10V | PERFIL REFUERZO TRASERA PUERTA PRZ-50 |
|--|---|---|--|---|---|---|
| | código 143260*** | código 144260*** | código 165260*** | código 126400*** | código 127400*** | código 118300A02 |
| |  |  |  |  |  |  |
| |  |  |  |  |  |  |
| longitud | 2,6 m | 2,6 m | 2,6 m | 4 m | 4 m | 3 m |
| embalaje industria cantidad mínima* | caja 20 tiras | caja 20 tiras | caja 20 tiras | paquete 10 tiras | paquete 10 tiras | paquete 10 tiras |
| acabados *** | | | | | | |
| acabado aluminio | | | | | | |
| lacado blanco A01 | | | 2,90 m cod. 165290A01 | | | |
| plata mate A02 | | | 2,90 m cod. 165290A02 | | | |
| chapa sin barnizar | | | | | | |
| roble s/b C01 | | | | | | |
| sapelly s/b C02 | | | | | | |
| fresno s/b C03 | | | | | | |
| cerezo s/b C04 | | | | | | |
| haya s/b C05 | | | | | | |
| pino s/b C06 | | | | | | |
| haya vaporizada s/b C07 | | | | | | |
| papel melamina | | | | | | |
| roble claro A-412 P02 | | | | | | |
| sapelly D-468 P03 | | | | | | |
| pino C-419 P04 | | | | | | |
| cerezo H-450 P05 | | | | | | |
| haya vaporizada H-428 P06 | | | | | | |
| roble oscuro A-725 P07 | | | | | | |
| cerezo tajo H-2428 P08 | | | | | | |
| wengue congo D-0427 P09 | | | | | | |
| blanco W-402 P84 | | | | | | |

* NOTA IMPORTANTE: Embalaje industria - pedido mínimo, la perfilería de aluminio será suministrada por caja en la cantidad mínima indicada.

**SERIE
MAX-60
S75**

10 mm

**TIRADOR
TR10-MAX60**

código **167260*****

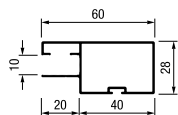

**PERFIL "H"
HORIZONTAL
PRH10-MAX60**

código **119400*****

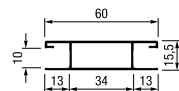

**PERFI LATERAL
UNERO VERTICAL
PLU15**

código **168270*****

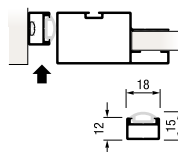

| | | | |
|----------------------------------|------------------|-----------------|------------------|
| longitud | 2,6 m | 4 m | 2,7 m |
| embalaje industria | | | |
| cantidad mínima* | caja de 10 tiras | paquete 5 tiras | caja de 10 tiras |
| acabados *** | | | |
| acabado aluminio | | | |
| plata mate A02 | • | • | • |
| chapa sin barnizar | | | |
| roble s/b C01 | • | • | • |
| sapelly s/b C02 | • | • | • |
| fresno s/b C03 | • | • | • |
| cerezo s/b C04 | • | • | • |
| haya s/b C05 | • | • | • |
| pino s/b C06 | • | • | • |
| haya vaporizada s/b C07 | • | • | • |
| papel melamina | | | |
| haya vaporizada H-428 P06 | • | • | • |
| roble oscuro A-725 P07 | • | • | • |
| cerezo tajo H-2428 P08 | • | • | • |
| wengue congo D-0427 P09 | • | • | • |
| blanco W-402 P84 | • | • | • |
| plata LY-2609 P92 | • | • | • |

* **NOTA IMPORTANTE:** Embalaje industria - pedido mínimo, la perfilería de aluminio será suministrada por caja en la cantidad mínima indicada.

**SERIE
CLASSIC
S75**

16 mm

**TIRADOR
TR16 MIN**

código 15M260***



**TIRADOR
TR16**

código 150260***

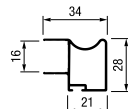

**TIRADOR
TR16ML**

código 151260***

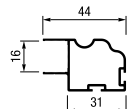

**TIRADOR
TR16RD**

código 152260***

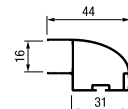
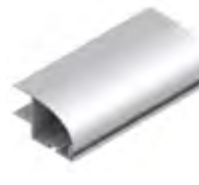

**PERFIL REMATE
"U" HORIZONTAL
PRU16**

código 121400***



**PERFIL "H" HORIZONTAL
PRH16**

código 123400***



**PERFIL "H" HORIZONTAL
PRH16-12**



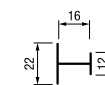







código 528400***

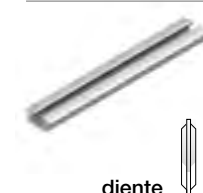

| | TIRADOR TR16 MIN | TIRADOR TR16 | TIRADOR TR16ML | TIRADOR TR16RD | PERFIL REMATE "U" HORIZONTAL PRU16 | PERFIL "H" HORIZONTAL PRH16 | PERFIL "H" HORIZONTAL PRH16-12 |
|--|------------------|--------------------------------|----------------|----------------|------------------------------------|-----------------------------|--------------------------------|
| longitud | 2,6 m | 2,6 m | 2,6 m | 2,6 m | 4 m | 4 m | 4 m |
| embalaje industria cantidad mínima* | caja 20 tiras | caja 20 tiras | caja 16 tiras | caja 16 tiras | paquete 10 tiras | paquete 10 tiras | paquete 10 tiras |
| acabados *** | | | | | | | |
| acabado aluminio | | | | | | | |
| lacado blanco A01 | • | 2,90 m cod. 150290A01 • | • | • | • | • | • |
| plata mate A02 | • | 2,90 m cod. 150290A02 • | • | • | • | • | • |
| oro mate repulido A03 | • | • | • | • | • | • | • |
| bronce mate repulido A04 | • | • | • | • | • | • | • |
| oro brillo repulido A10 | • | • | • | • | • | • | • |
| lacado inox A11 | • | • | • | • | • | • | • |
| chapa sin barnizar | | | | | | | |
| roble s/b C01 | • | • | • | • | • | • | • |
| sapelly s/b C02 | • | • | • | • | • | • | • |
| fresno s/b C03 | • | • | • | • | • | • | • |
| cerezo s/b C04 | • | • | • | • | • | • | • |
| haya s/b C05 | • | • | • | • | • | • | • |
| pino s/b C06 | • | • | • | • | • | • | • |
| haya vaporizada s/b C07 | • | • | • | • | • | • | • |
| papel melamina | | | | | | | |
| roble claro A-412 P02 | • | • | • | • | • | • | • |
| sapelly D-468 P03 | • | • | • | • | • | • | • |
| pino C-419 P04 | • | • | • | • | • | • | • |
| cerezo H-450 P05 | • | • | • | • | • | • | • |
| haya vaporizada H-428 P06 | • | • | • | • | • | • | • |
| roble oscuro A-725 P07 | • | • | • | • | • | • | • |
| cerezo tajo H-2428 P08 | • | • | • | • | • | • | • |
| wengue congo D-0427 P09 | • | • | • | • | • | • | • |
| blanco W-402 P84 | • | • | • | • | • | • | • |

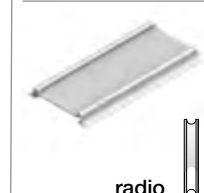
* NOTA IMPORTANTE: Embalaje industria - pedido mínimo, la perfilería de aluminio será suministrada por caja en la cantidad mínima indicada.

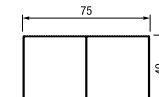
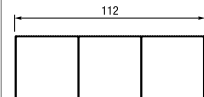
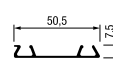
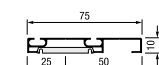
CARRILES S75

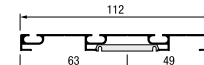
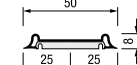
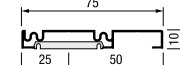
| | CARRIL ALTO CAA75 | CARRIL ALTO TRIPLE CA3G-S75 | CARRIL BAJO CBD50 | CARRIL BAJO CBD75 "easy clip" | CARRIL BAJO EMPOTRADO CBE16 | CARRIL BAJO TRIPLE CB3G-S75 "easy clip" | CARRIL BAJO CBR50 "easy clip" | CARRIL BAJO CBR75 "easy clip" |
|----------------------------------|---|---|---|---|---|---|---|---|
| código | 110400*** | código 108400*** | código 111400*** | código 112400*** | código 116400*** | código 109400*** | código 113600*** | código 114600*** |
| código | 110400ZPM*** | código 108600*** | código 111600*** | código 112600*** | | código 109600*** | | |
| código | 110600*** | | | | | | | |
| código | 110600ZPM*** | | | | | | | |
| |  |  |  |  |  |  |  |  |
| |  |  |  |  |  |  |  |  |
| longitud | 4 m - 6 m | 4 m - 6 m | 4 m - 6 m | 4 m - 6 m | 4 m | 4 m - 6 m | 6 m | 6 m |
| embalaje | caja 8 tiras | caja 8 tiras | paquete 8 tiras | paquete 8 tiras | paquete 16 tiras | paquete 8 tiras | paquete 8 tiras | paquete 8 tiras |
| acabados *** | | | | | | | | |
| acabado aluminio | 110400*** | | | | | | | |
| | 110600*** | | | | | | | |
| lacado blanco A01 | • | | • | • | • | • | • | • |
| plata mate A02 | • | • | • | • | • | • | • | • |
| oro mate repulido A03 | • | | • | • | • | • | • | • |
| bronce mate repulido A04 | • | | • | • | • | • | • | • |
| oro brillo repulido A10 | • | | • | • | • | • | • | • |
| lacado inox A11 | • | | • | • | • | • | • | • |
| chapa sin barnizar | 110400ZPM*** | | | | | | | |
| | 110600ZPM*** | | | | | | | |
| roble s/b C01 | • | | | • | | | | |
| sapelly s/b C02 | • | | | • | | | | |
| fresno s/b C03 | • | | | • | | | | |
| cerezo s/b C04 | • | | | • | | | | |
| haya s/b C05 | • | | | • | | | | |
| pino s/b C06 | • | | | • | | | | |
| haya vaporizada s/b C07 | • | | | • | | | | |
| papel melamina | 110400ZPM*** | | | | | | | |
| | 110600ZPM*** | | | | | | | |
| roble claro A-412 P02 | • | | | • | | | | |
| sapelly D-468 P03 | • | | | • | | | | |
| pino C-419 P04 | • | | | • | | | | |
| cerezo H-450 P05 | • | | | • | | | | |
| haya vaporizada H-428 P06 | • | | | • | | | | |
| roble oscuro A-725 P07 | • | | | • | | | | |
| cerezo tajo H-2428 P08 | • | | | • | | | | |
| wengue congo D-0427 P09 | • | | | • | | | | |
| blanco W-402 P84 | • | | | • | | | | |

* **NOTA IMPORTANTE:** La medida de 6 metros sólo será servida por paquetes completos y será gestionada como un pedido independiente realizado por transporte especial. Ver condiciones generales de transporte.

* **NOTA IMPORTANTE:** Embalaje industria - pedido mínimo, la perfilería de aluminio será suministrada por caja en la cantidad mínima indicada.



EMBALAJE KIT

**KIT 2 RUEDAS ALTAS + 2 RUEDAS BAJAS
PUERTA CORREDERA TERRA S75**

código **100S75N00**



composición del kit de ruedas:

- 2 ruedas inferiores diente
 - 2 ruedas superiores
 - Tornillería varia
- Caja de 30 kits

**RUEDAS
SUPERIORES
S75**

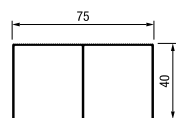

carril alto 75 mm

EMBALAJE INDUSTRIA

**RUEDA SUPERIOR
RODAMIENTO S75**

código **102R0DS75**



zincado plata

bolsa de 25 unidades
caja de 200 unidades

**RUEDA SUPERIOR
ROLDANA S75**

código **102R0LS75**



zincado plata

bolsa de 25 unidades
caja de 200 unidades

**RUEDA SUPERIOR
ANTIVUELCO**

código **802ANV000**



zincado plata

caja de 100 unidades

**RUEDAS
INFERIORES
S75**



diente

EMBALAJE INDUSTRIA

**RUEDA INFERIOR
Ø60 DIENTE**

código **101D60001**



zincado plata

caja de 50 unidades

**RUEDA INFERIOR
Ø60 DIENTE NEGRA**

código **101D60002**



zincado negro

caja de 50 unidades

**RUEDA INFERIOR
Ø60 RADIO
S75**

código **101R60001**

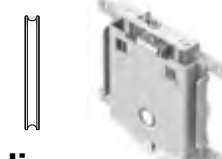

radio

zincado plata

caja de 50 unidades



easy soft
patente registrada

El innovador sistema de apertura y cierre amortiguado “Easy Soft” Terra de Syskor permite la fabricación de armarios empotrados de altas prestaciones con una extraordinaria **suavidad de funcionamiento** incluso para puertas de **hasta 40 Kg de peso**.

Este revolucionario diseño de **amortiguación integrado en la rueda superior** facilita y ahorra tiempo de montaje posicionando automáticamente el sistema de frenado y **garantizando su perfecto ajuste**.

EMBALAJE KIT

KIT 2 RUEDAS ALTAS CON CIERRE AMORTIGUADO PARA PUERTA CORREDERA TERRA S75

| | peso por puerta | |
|---------------------------------|------------------|---|
| medio cod. 104S75ES2 | hasta 25 Kg | • |
| fuerte cod. 104S75ES3 | de 25 Kg a 40 Kg | • |

composición del kit de ruedas superiores easy soft:

- 2 ruedas superiores con amortiguación integrada
- 2 activadores
- Tornillería varia

Cajas de 20 kits



KIT 2 RETENEDORES AUTOCIERRE T-15 / T-40

código peso de puerta

804RETACK015 HASTA 15 Kg

804RETACK040 HASTA 40 Kg

kit compuesto de:

2 retenedores, 2 activadores, 4 soportes, tornillos e instrucciones.
(caja 25 kits)



KIT 2 RETENEDORES AUTOCIERRE T-60 / T-80

código peso de puerta

804RETACK060 HASTA 60 Kg

804RETACK080 HASTA 80 Kg

kit compuesto de:

2 retenedores, 2 activadores, 4 soportes, tornillos e instrucciones.
(caja 25 kits)



**KIT RETENEDOR CENTRAL TERRA / BASE PARA ARMARIOS DE 3 PUERTAS
(POLIVALENTE PARA PROGRAMAS TERRA Y BASE)**

código peso de puerta

804RETCEN HASTA 40 Kg

kit compuesto de:

1 retenedor, 1 activador, 1 juego soportes Terra, 1 juego
soportes Base, tornillos e instrucciones.

(caja de 20 kits)

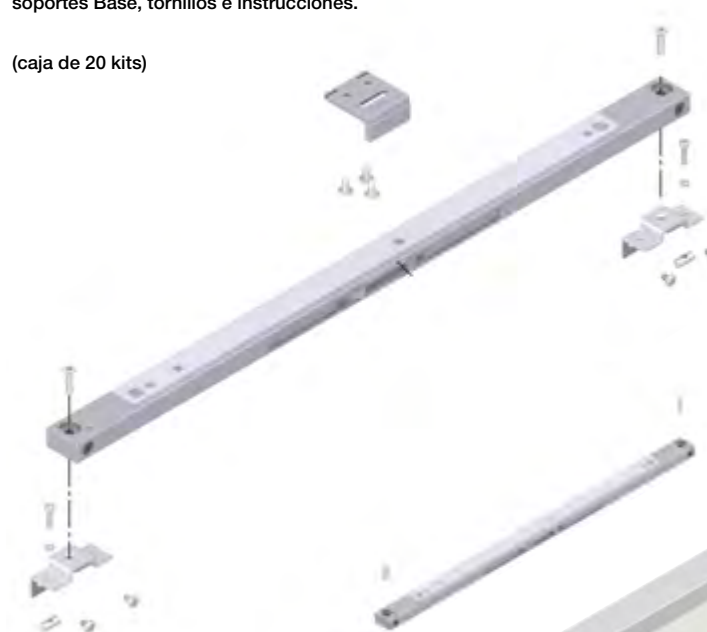

| | | | | | | | | | |
|--|---|---|---|---|---|--|--|---|---|
| <p>GOMA TR10 CRISTAL 4 mm</p> <p>código 104GOMTRA</p>  <p>PVC transparente</p> <p>ancho de 6 mm</p>  <p>crystal 4 / perfil 10 mm</p> <p>rollo 100 m</p> | <p>GOMA TR10 CRISTAL 5 mm</p> <p>código 104GOM014</p>  <p>PVC transparente</p> <p>ancho de 5 mm</p>  <p>crystal 5 / perfil 10 mm</p> <p>rollo 100 m</p> | <p>GOMA TR10 CRISTAL 6 mm</p> <p>código 804004000</p>  <p>PVC transparente</p> <p>ancho de 4 mm</p>  <p>crystal 6 / perfil 10 mm</p> <p>rollo 100 m</p> | <p>GOMA TR10 CRISTAL 8 mm</p> <p>código 804002000</p>  <p>PVC transparente</p> <p>ancho de 2 mm</p>  <p>crystal 8 / perfil 10 mm</p> <p>rollo 200 m</p> | <p>GOMA TR16 CRISTAL 4 mm</p> <p>código 104GOMTR16</p>  <p>PVC transparente</p> <p>ancho de 12 mm</p>  <p>crystal 4 / perfil 16 mm</p> <p>rollo 50 m</p> | <p>GOMA TR19 CRISTAL 4 mm</p> <p>código 104GOMTR19</p>  <p>PVC transparente</p> <p>ancho de 15 mm</p>  <p>crystal 4 / perfil 19 y 18 mm</p> <p>caja de 1 rollo de 50m</p> | <p>MOLDURA MDF CRISTAL 4 mm MIN10</p> <p>código 223260100</p>  <p>serie MINIMAL (10 mm)</p>  <p>crystal 4 / perfil 10 mm</p> <p>2,6 m paquete 10 tiras</p> | <p>MOLDURA MDF CRISTAL 4 mm MIN16</p> <p>código 223260160</p>  <p>serie MINIMAL (16 mm)</p>  <p>crystal 4 / perfil 16 mm</p> <p>2,6 m paquete 10 tiras</p> | <p>TORNILLO R/CHAPA 3,5X6,5</p> <p>código 1000000001</p>  <p>zincado plata</p>  <p>caja de 1.000 unidades</p> | <p>ARANDELA ESPECIAL 4,3X9X1,4</p> <p>código 1000000002</p>  <p>plástico blanco</p>  <p>bolsa de 1.000 unidades</p> |
| <p>PERFIL PVC LATERAL TRANSPARENTE</p> <p>código 104LAT000</p>  <p>tiradores TR (lateral)</p>  <p>rollo 250 m</p> | <p>CEPILLO LATERAL 6,5 mm</p> <p>código blanco 103065001 negro 103065002</p>  <p>tiradores TR (lateral) tiradores KT (trasera)</p>  <p>bobinas 300 m</p> | <p>CEPILLO TRASERO 10 mm</p> <p>código blanco 103100001 negro 103100002</p>  <p>tiradores TR (trasera)</p>  <p>bobinas 300 m</p> | <p>PAPEL ADHESIVO NEGRO 45 cm</p> <p>código 104ADH002</p>  <p>papel adhesivo negro</p> <p>rollo 20 m</p> | <p>ESCUADRA PLANA 40X10</p> <p>código 100000003</p>  <p>zincado plata</p>  <p>caja de 100 unidades</p> | <p>PLETINA UNIÓN JAPONESA</p> <p>código 800000004</p>  <p>zincado plata</p>  <p>caja de 100 unidades</p> | <p>FRENO METAL CARRIL BAJO</p> <p>código 804FRE000</p>  <p>acero inox</p> <p>compatible con carriles: CBD80 CBD58 CBD55 CBD75 BASIC</p> <p>caja 100 unidades</p> | <p>FRENO CARRIL BAJO ZAMAK</p> <p>código 104FRE000</p>  <p>bolsa de 50 unidades</p> <p>válido para: CBD50 CBD75 CBD85 CBE16</p> | <p>HERRAJE ANCLAJE CARRIL BAJO</p> <p>código 104ANC000</p>  <p>plástico gris</p> <p>compatible con carriles: CBD75 CBD85 CBD60</p> <p>bolsa de 50 unidades caja de 20 bolsas</p> | |

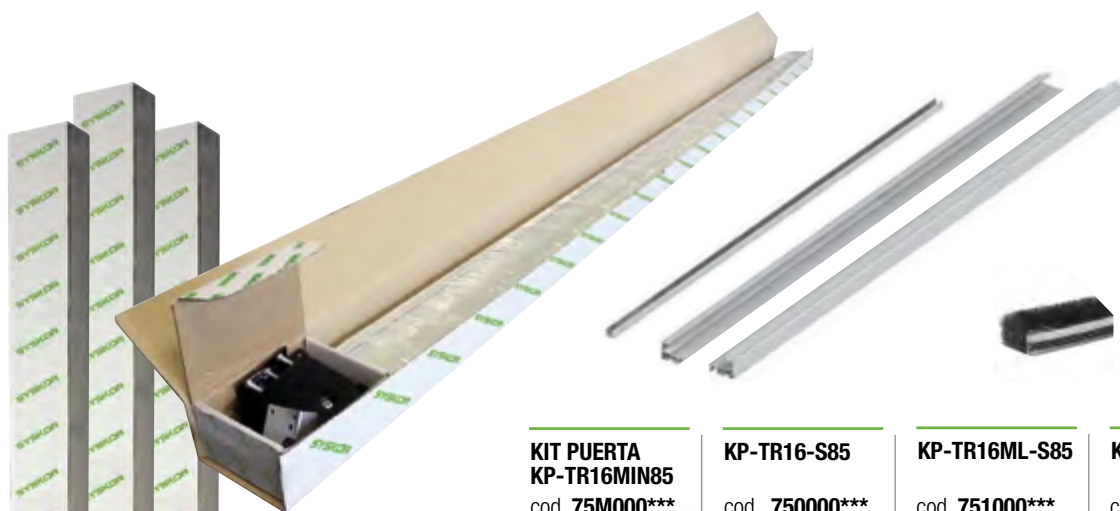

composición del kit de puerta:

- 2 ruedas inferiores
 - 2 ruedas superiores
 - tornillería varia
 - cepillo
 - 2 perfiles tiradores (2 x 2,6 m)
 - 1 perfil horizontal (superior / inferior) (1 x 2 m)
- *tablero no incluido



| KIT PUERTA KP-TR16MIN85 cod. 75M000*** | KP-TR16-S85 cod. 750000*** | KP-TR16ML-S85 cod. 751000*** | KP-TR16RD-S85 cod. 752000*** | KP-TR16V1-S85 cod. 743000*** | KP-TR16V2-S85 cod. 744000*** | KP-TR16V4-S85 cod. 746000*** | KP-TR16V7-S85 cod. 747000*** |
|---|---|---|---|---|---|---|---|
|  |  |  |  |  |  |  |  |
|  |  |  |  |  |  |  |  |
| 2,6 m | 2,6 m | 2,6 m | 2,6 m | 2,6 m | 2,6 m | 2,6 m | 2,6 m |

| acabados *** | | | | | | | | |
|---------------------------|---|---|---|---|---|---|---|---|
| acabado aluminio | | | | | | | | |
| lacado blanco A01 | • | • | • | • | • | • | • | • |
| plata mate A02 | • | • | • | • | • | • | • | • |
| oro brillo repulido A10 | | • | | | | | | |
| chapa sin barnizar | | | | | | | | |
| roble s/b C01 | • | • | • | • | • | • | • | • |
| sapelly s/b C02 | • | • | • | • | • | • | • | • |
| fresno s/b C03 | • | • | • | • | • | • | • | • |
| cerezo s/b C04 | • | • | • | • | • | • | • | • |
| haya s/b C05 | • | • | • | • | • | • | • | • |
| pino s/b C06 | • | • | • | • | • | • | • | • |
| haya vaporizada s/b C07 | • | • | • | • | • | • | • | • |
| papel melamina | | | | | | | | |
| roble claro A-412 P02 | | • | • | • | • | • | • | • |
| sapelly D-468 P03 | | • | • | • | • | • | • | • |
| pino C-419 P04 | | • | • | • | • | • | • | • |
| cerezo H-450 P05 | | • | • | • | • | • | • | • |
| haya vaporizada H-428 P06 | • | • | • | • | • | • | • | • |
| roble oscuro A-725 P07 | • | • | • | • | • | • | • | • |
| cerezo tajo H-2428 P08 | • | • | • | • | • | • | • | • |
| wengue congo D-0427 P09 | • | • | • | • | • | • | • | • |
| blanco W-402 P84 | • | • | • | • | • | • | • | • |

Caja interior autoventa de 1 kit

* Embalaje exterior de 4 kits

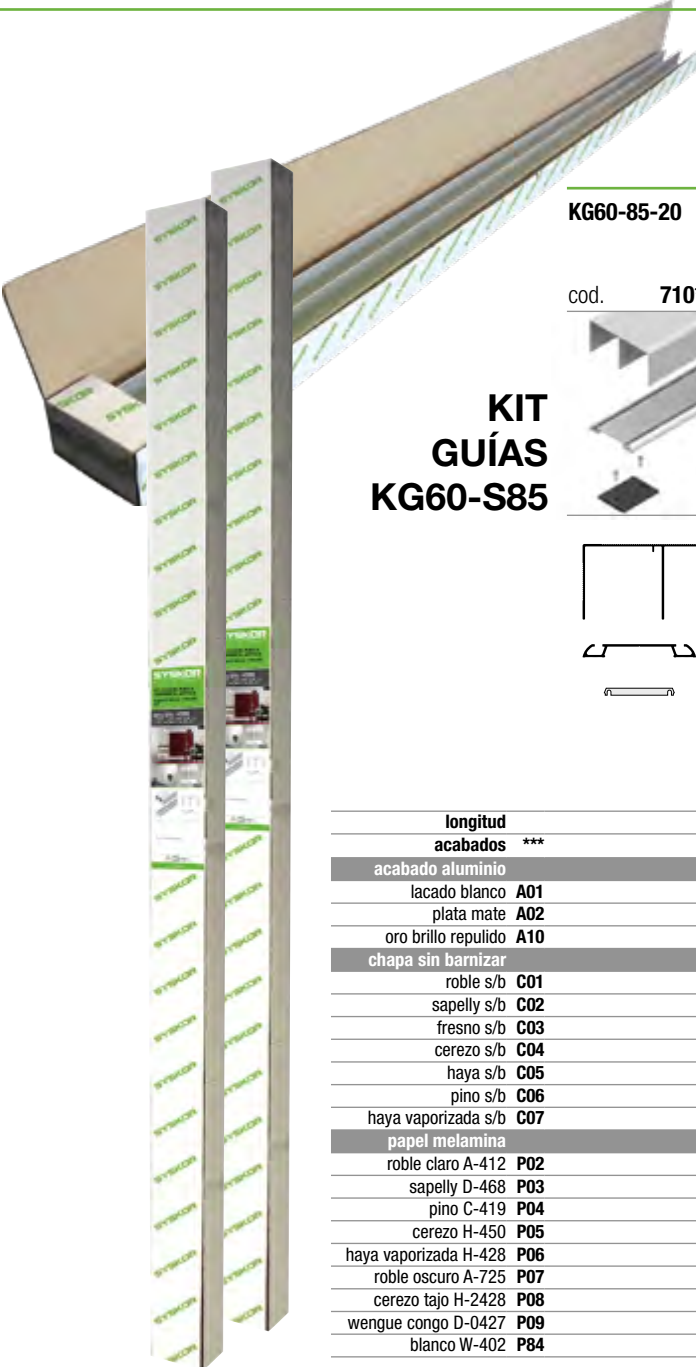

**KIT
GUÍAS
KG60-S85**

| KG60-85-20 | KG60-85-30 | KG60-85-40 |
|----------------|----------------|----------------|
| cod. 710***200 | cod. 710***300 | cod. 710***400 |
| | | |
| | | |
| | | |

**KIT
GUÍAS
KG85-S85**

| KG85-S85-20 | KG85-S85-30 | KG85-S85-40 |
|----------------|----------------|----------------|
| cod. 712***200 | cod. 712***300 | cod. 712***400 |
| | | |
| | | |
| | | |

| | 2 m | 3 m | 4 m | 2 m | 3 m | 4 m |
|----------------------------------|-----|-----|-----|-----|-----|-----|
| longitud | 2 m | 3 m | 4 m | 2 m | 3 m | 4 m |
| acabados *** | | | | | | |
| acabado aluminio | | | | | | |
| lacado blanco A01 | • | • | • | • | • | • |
| plata mate A02 | • | • | • | • | • | • |
| oro brillo repulido A10 | | | | • | • | |
| chapa sin barnizar | | | | | | |
| roble s/b C01 | | | | • | • | • |
| sapelly s/b C02 | | | | • | • | • |
| fresno s/b C03 | | | | • | • | • |
| cerezo s/b C04 | | | | • | • | • |
| haya s/b C05 | | | | • | • | • |
| pino s/b C06 | | | | • | • | • |
| haya vaporizada s/b C07 | | | | • | • | • |
| papel melamina | | | | | | |
| roble claro A-412 P02 | | | | • | • | • |
| sapelly D-468 P03 | | | | • | • | • |
| pino C-419 P04 | | | | • | • | • |
| cerezo H-450 P05 | | | | • | • | • |
| haya vaporizada H-428 P06 | | | | • | • | • |
| roble oscuro A-725 P07 | | | | • | • | • |
| cerezo tajo H-2428 P08 | | | | • | • | • |
| wengue congo D-0427 P09 | | | | • | • | • |
| blanco W-402 P84 | | | | • | • | • |

Caja interior autoventa de 1 kit

* Embalaje exterior de 4 kits

**SERIE
CLASSIC
S85**

16mm

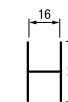
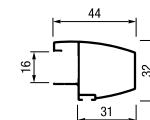
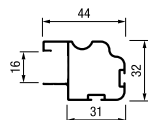
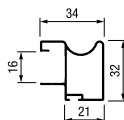

| | | | | | | |
|----------------------------------|---------------|---------------|---------------|---------------|------------------|------------------|
| longitud | 2,6 m | 2,6 m | 2,6 m | 2,6 m | 4 m | 4 m |
| embalaje industria | caja 20 tiras | caja 20 tiras | caja 16 tiras | caja 16 tiras | paquete 10 tiras | paquete 10 tiras |
| cantidad mínima* | | | | | | |
| acabados *** | | | | | | |
| acabado aluminio | | | | | | |
| lacado blanco A01 | • | • | • | • | • | • |
| plata mate A02 | • | • | • | • | • | • |
| oro mate repulido A03 | | | | | • | • |
| bronce mate repulido A04 | | | | | • | • |
| oro brillo repulido A10 | | | | | • | • |
| lacado inox A11 | | | | | • | • |
| chapa sin barnizar | | | | | | |
| roble s/b C01 | • | • | • | • | • | • |
| sapelly s/b C02 | • | • | • | • | • | • |
| fresno s/b C03 | | • | • | • | • | • |
| cerezo s/b C04 | • | • | • | • | • | • |
| haya s/b C05 | • | • | • | • | • | • |
| pino s/b C06 | • | • | • | • | • | • |
| haya vaporizada s/b C07 | • | • | • | • | • | • |
| papel melamina | | | | | | |
| roble claro A-412 P02 | | • | • | • | • | • |
| sapelly D-468 P03 | | • | • | • | • | • |
| pino C-419 P04 | | • | • | • | • | • |
| cerezo H-450 P05 | | • | • | • | • | • |
| haya vaporizada H-428 P06 | • | • | • | • | • | • |
| roble oscuro A-725 P07 | • | • | • | • | • | • |
| cerezo tajo H-2428 P08 | • | • | • | • | • | • |
| wengue congo D-0427 P09 | • | • | • | • | • | • |
| blanco W-402 P84 | • | • | • | • | • | • |

* NOTA IMPORTANTE: Embalaje industria - pedido mínimo, la perfilería de aluminio será suministrada por caja en la cantidad mínima indicada.

**SERIE
MINIMAL
S85**

16mm

| | TIRADOR TR16V1-S85 | TIRADOR TR16V2-S85 | TIRADOR TR16V4-S85 | TIRADOR TR16V7-S85 | PERFIL REMATE "U" HORIZONTAL PRU16 V85 | PERFIL "H" HORIZONTAL PRH16-12 | PERFIL REFUERZO TRASERA PUERTA PRZ-50 |
|----------------------------------|---|---|--|---|---|---|---|
| | código 543260*** | código 544260*** | código 546260*** | código 547260*** | código 526400*** | código 528400*** | código 118300A02 |
| |  |  |  |  |  |  |  |
| |  |  |  |  |  |  |  |
| longitud | 2,6 m | 2,6 m | 2,6 m | 2,6 m | 4 m | 4 m | 3 m |
| embalaje industria | caja 20 tiras | caja 20 tiras | caja 20 tiras | caja 20 tiras | paquete 10 tiras | paquete 10 tiras | paquete 10 tiras |
| cantidad mínima* | | | | | | | |
| acabados *** | | | | | | | |
| acabado aluminio | | | | | | | |
| lacado blanco A01 | | | | | • | • | • |
| plata mate A02 | • | • | • | • | • | • | • |
| lacado inox A11 | | | | | • | • | • |
| chapa sin barnizar | | | | | | | |
| roble s/b C01 | • | • | • | • | • | • | • |
| sapelly s/b C02 | • | • | • | • | • | • | • |
| fresno s/b C03 | • | • | • | • | • | • | • |
| cerezo s/b C04 | • | • | • | • | • | • | • |
| haya s/b C05 | • | • | • | • | • | • | • |
| pino s/b C06 | • | • | • | • | • | • | • |
| haya vaporizada s/b C07 | • | • | • | • | • | • | • |
| papel melamina | | | | | | | |
| roble claro A-412 P02 | • | • | • | • | • | • | • |
| sapelly D-468 P03 | • | • | • | • | • | • | • |
| pino C-419 P04 | • | • | • | • | • | • | • |
| cerezo H-450 P05 | • | • | • | • | • | • | • |
| haya vaporizada H-428 P06 | • | • | • | • | • | • | • |
| roble oscuro A-725 P07 | • | • | • | • | • | • | • |
| cerezo tajo H-2428 P08 | • | • | • | • | • | • | • |
| wengue congo D-0427 P09 | • | • | • | • | • | • | • |
| blanco W-402 P84 | • | • | • | • | • | • | • |
| plata LY-2609 P92 | • | • | • | • | • | • | • |

* NOTA IMPORTANTE: Embalaje industria - pedido mínimo, la perfilería de aluminio será suministrada por caja en la cantidad mínima indicada.

**CARRILES S85
PARA TABLERO
DE 16 Y 19 MM**

**CARRIL ALTO
CAA85**

código 510400***
código 510600***

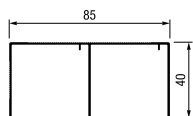

**CARRIL BAJO
CBD60 "easy clip"**

código 511400***
código 511600***

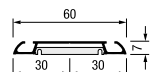

**CARRIL BAJO
CBD85-10 "easy clip"**

código 513400***
código 513600***

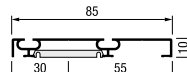

diente

**SERIE
MAX-60
S85**

16mm

**TIRADOR
TR16-MAX60**

código 567260***

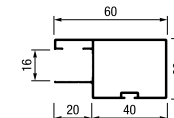

**PERFIL "H"
HORIZONTAL
PRH16-MAX60**

código 519400***

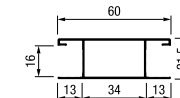

**PERFIL LATERAL
UNERO VERTICAL
PLU15**

código 168270***

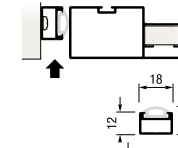

| | | | |
|--|-----------------|--------------------|--------------------|
| longitud | 4 m - 6 m | 4 m - 6 m | 4 m - 6 m |
| embalaje industria cantidad mínima* | caja de 8 tiras | paquete de 8 tiras | paquete de 8 tiras |
| acabados *** | | | |
| acabado aluminio | | | |
| lacado blanco A01 | • | • | • |
| plata mate A02 | • | • | • |
| chapa sin barnizar | | | |
| roble s/b C01 | • | | • |
| sapelly s/b C02 | • | | • |
| fresno s/b C03 | • | | • |
| cerezo s/b C04 | • | | • |
| haya s/b C05 | • | | • |
| pino s/b C06 | • | | • |
| haya vaporizada s/b C07 | • | | • |
| papel melamina | | | |
| roble claro A-412 P02 | • | | • |
| sapelly D-468 P03 | • | | • |
| pino C-419 P04 | • | | • |
| cerezo H-450 P05 | • | | • |
| haya vaporizada H-428 P06 | • | | • |
| roble oscuro A-725 P07 | • | | • |
| cerezo tajo H-2428 P08 | • | | • |
| wengue congo D-0427 P09 | • | | • |
| blanco W-402 P84 | • | | • |
| plata LY-2609 P92 | • | | • |

| | | | |
|--|------------------|--------------------|---------------------|
| | 2,6 m | 4 m | 2,7 m |
| | caja de 10 tiras | paquete de 5 tiras | paquete de 10 tiras |
| | | | |
| | | | |
| | | | • |
| | • | • | • |
| | • | • | • |
| | • | • | • |
| | • | • | • |
| | • | • | • |
| | • | • | • |
| | • | • | • |
| | • | • | • |
| | • | • | • |
| | • | • | • |
| | • | • | • |

* **NOTA IMPORTANTE:** La medida de 6 metros sólo será servida por paquetes completos y será gestionada como un pedido independiente realizado por transporte especial. Ver condiciones generales de transporte.

* **NOTA IMPORTANTE:** Embalaje industria - pedido mínimo, la perfilera de aluminio será suministrada por caja en la cantidad mínima indicada.



EMBALAJE KIT

**KIT 2 RUEDAS ALTAS + 2 RUEDAS BAJAS
PUERTA CORREDERA TERRA S85**

código **100S85N00**



composición del kit de ruedas:

- 2 ruedas inferiores diente
 - 2 ruedas superiores
 - Tornillería varia
- Caja de 30 kits

**RUEDAS
SUPERIORES
S85**

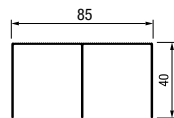

carril alto 85 mm

EMBALAJE INDUSTRIA

**RUEDA SUPERIOR
RODAMIENTO S85**

código **102RODS85**



zincado plata

bolsa de 25 unidades
caja de 200 unidades

**RUEDA SUPERIOR
ANTIVUELCO**

código **802ANV000**



zincado plata

caja de 100 unidades

**RUEDAS
INFERIORES**

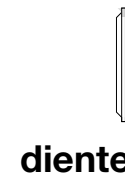

EMBALAJE INDUSTRIA

**RUEDA INFERIOR
Ø60 DIENTE**

código **101D60001**



zincado plata

caja de 50 unidades

**RUEDA INFERIOR
Ø60 DIENTE NEGRA**

código **101D60002**



zincado negro

caja de 50 unidades

* NOTA IMPORTANTE: Embalaje industria - pedido mínimo, los artículos serán suministrados por caja en la cantidad mínima indicada.





easy soft
patente registrada

El innovador sistema de apertura y cierre amortiguado **“Easy Soft” Terra de Syskor** permite la fabricación de armarios empotrados de altas prestaciones con una extraordinaria **suavidad de funcionamiento** incluso para puertas de **hasta 40 Kg de peso**.

Este revolucionario diseño de **amortiguación integrado en la rueda superior** facilita y ahorra tiempo de montaje posicionando automáticamente el sistema de frenado y **garantizando su perfecto ajuste**.

EMBALAJE KIT

KIT 2 RUEDAS ALTAS CON CIERRE AMORTIGUADO PARA PUERTA CORREDERA TERRA S85

| | peso por puerta | |
|---------------------------------|------------------|---|
| medio cod. 104S85ES2 | hasta 25 Kg | • |
| fuerte cod. 104S85ES3 | de 25 Kg a 40 Kg | • |

composición del kit de ruedas superiores easy soft:

- 2 ruedas superiores con amortiguación integrada
- 2 activadores
- Tornillería varia

Cajas de 20 kits



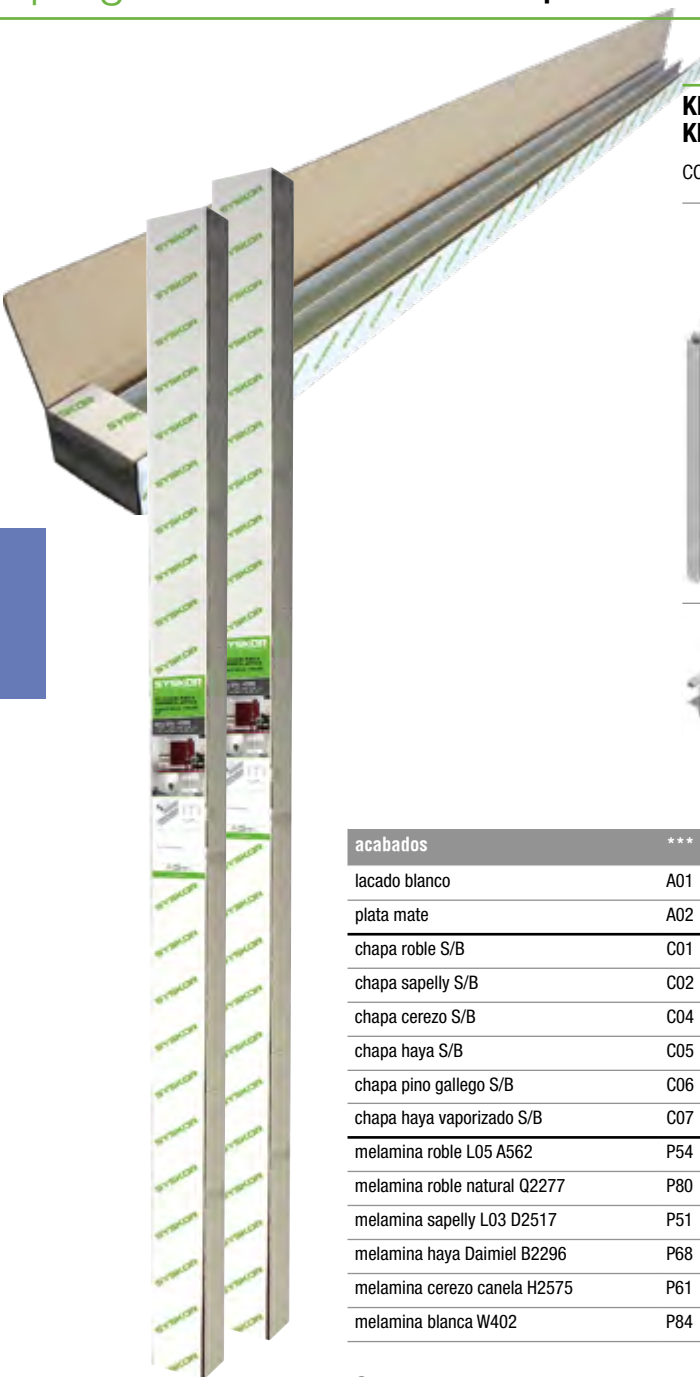

**KIT PUERTA
KPTR16-S80**

cod. **735000*****

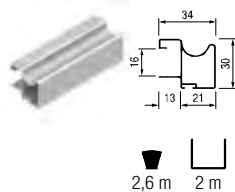

**KIT PUERTA
KPTR16-MIN-S80**

cod. **73M000*****

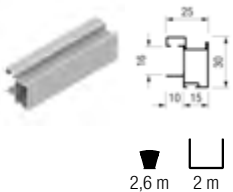

**KIT PUERTA
KPTR16-V7-S80**

cod. **73V000*****

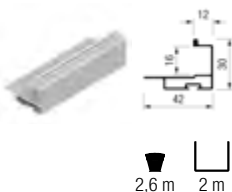

**KIT GUÍAS
KG86-S80**

cod. **732***200**

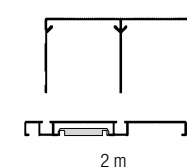

**KIT GUÍAS
KG86-S80**

cod. **732***300**

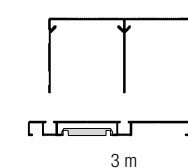

**KIT GUÍAS
KG86-S80**

cod. **732***400**

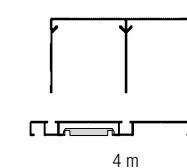

| acabados | *** | | | | | | |
|------------------------------|-----|---|---|---|--|---|---|
| lacado blanco | A01 | • | • | | | • | • |
| plata mate | A02 | • | • | • | | • | • |
| chapa roble S/B | C01 | • | | | | • | • |
| chapa sapelly S/B | C02 | • | | | | • | • |
| chapa cerezo S/B | C04 | • | | | | • | • |
| chapa haya S/B | C05 | • | | | | • | • |
| chapa pino gallego S/B | C06 | • | | | | • | • |
| chapa haya vaporizado S/B | C07 | • | | | | • | • |
| melamina roble L05 A562 | P54 | • | | | | • | • |
| melamina roble natural Q2277 | P80 | • | | | | • | • |
| melamina sapelly L03 D2517 | P51 | • | | | | • | • |
| melamina haya Daimiel B2296 | P68 | • | | | | • | • |
| melamina cerezo canela H2575 | P61 | • | | | | • | • |
| melamina blanca W402 | P84 | • | | | | • | • |

Caja interior autoventa de 1 kit

* Embalaje exterior de 4 kits

RUEDA SUPERIOR RODAMIENTO S80
cod. **102RODS80**



bolsa de 25 unidades
caja de 200 unidades

RUEDA INFERIOR Ø60 DIENTE
cod. **101D60001**



zincado plata
caja de 50 unidades

SUJECCIÓN DE CARRIL INFERIOR R3 (CPOXX300)

cod. **800000016**



bolsa de 50 unidades

TIRADOR TR16-S80
cod. **535260*****

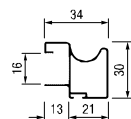

longitud 2,60 m
embalaje industria
caja de 20 tiras

TIRADOR TR16-MIN-S80
cod. **53M260*****



longitud 2,60 m
embalaje industria
caja de 20 tiras

TIRADOR TR16-V7-S80
cod. **53V260*****

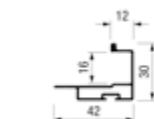

longitud 2,60 m
embalaje industria
caja de 20 tiras

PERFIL REMATE "U" HTAL PRU-16
cod. **121400*****



longitud 4 m
embalaje industria
paquete de 10 tiras

PERFIL "H" HTAL PRH16-12
cod. **528400*****

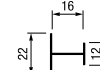

longitud 4 m
embalaje industria
paquete de 10 tiras

CARRIL ALTO CAA80
cod. **530600*****

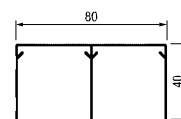

longitud 6 m
embalaje industria
caja de 8 tiras

CARRIL BAJO CBD80-S80
cod. **532600*****

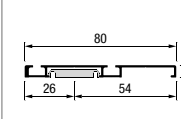
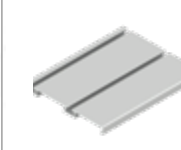

longitud 6 m
embalaje industria
paquete de 8 tiras

CARRIL BAJO CBD58-S80
cod. **531600*****

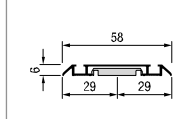

longitud 6 m
embalaje industria
paquete de 8 tiras

| acabados | *** | | | | | | | | |
|------------------------------|-----|---|---|---|---|---|---|---|---|
| lacado blanco | A01 | • | • | | • | • | • | • | • |
| plata mate | A02 | • | • | • | • | • | • | • | • |
| chapa roble S/B | C01 | • | | | • | • | • | • | |
| chapa roble barnizado | D01 | • | | | • | • | • | • | |
| chapa sapelly S/B | C02 | • | | | • | • | • | • | |
| chapa cerezo S/B | C04 | • | | | • | • | • | • | |
| chapa haya S/B | C05 | • | | | • | • | • | • | |
| chapa pino gallego S/B | C06 | • | | | • | • | • | • | |
| chapa haya vaporizado S/B | C07 | • | | | • | • | • | • | |
| melamina roble L05 A562 | P54 | • | | | • | • | • | • | |
| melamina roble natural Q2277 | P80 | • | | | • | • | • | • | |
| melamina sapelly L03 D2517 | P51 | • | | | • | • | • | • | |
| melamina haya Daimiel B2296 | P68 | • | | | • | • | • | • | |
| melamina cerezo canela H2575 | P61 | • | | | • | • | • | • | |
| melamina blanca W402 | P84 | • | | | • | • | • | • | |

* **NOTA IMPORTANTE:** La medida de 6 metros sólo será servida por paquetes completos y será gestionada como un pedido independiente realizado por transporte especial. Ver condiciones generales de transporte.

* **NOTA IMPORTANTE:** Embalaje industria - pedido mínimo, la perfilaría de aluminio será suministrada por caja en la cantidad mínima indicada.



composición del kit de puerta:

- 2 ruedas inferiores
- 2 ruedas superiores
- tornillería varia
- cepillo
- 2 perfiles tiradores (2 x 2,6 m)
- 1 perfil horizontal (superior / inferior) (1 x 2 m)
- *tablero no incluido



**KIT DE PUERTA
KP TR16 BASIC**

código **337000*****

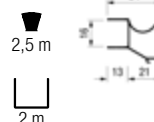

**KIT DE PUERTA
KP TR16 MIN BASIC**

código **33A000*****

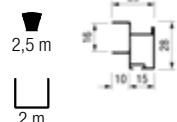

**KIT DE PUERTA
KP TR10 BASIC**

código **33B000*****

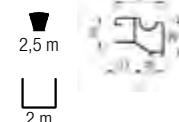

**KIT DE PUERTA
KP TR10 MIN BASIC**

código **33D000*****

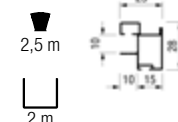

**KIT DE PUERTA
KP TR10 V7 BASIC**

código **33V000*****

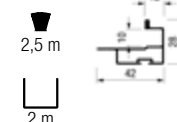

| acabados | *** | | | | |
|-----------------------|-----|---|---|---|---|
| acabado aluminio | | | | | |
| lacado blanco | A01 | • | • | • | • |
| plata mate | A02 | • | • | • | • |
| oro brillo repulido | A10 | • | | | |
| chapa sin barnizar | | | | | |
| roble s/b | C01 | • | | | |
| sapelly s/b | C02 | • | | | |
| fresno s/b | C03 | • | | | |
| cerezo s/b | C04 | • | | | |
| haya s/b | C05 | • | | | |
| pino s/b | C06 | • | | | |
| haya vaporizada s/b | C07 | • | | | |
| papel melamina | | | | | |
| roble claro A-412 | P02 | • | | | |
| sapelly D-468 | P03 | • | | | |
| pino C-419 | P04 | • | | | |
| cerezo H-450 | P05 | • | | | |
| haya vaporizada H-428 | P06 | • | | | |
| roble oscuro A-725 | P07 | • | | | |
| cerezo tajo H-2428 | P08 | • | | | |
| wengue congo D-0427 | P09 | • | | | |
| roble RO R-0444 | P50 | • | | | |
| blanco W-402 | P84 | • | | | |

Caja interior autoventa de 1 kit

* Embalaje exterior de 4 kits



**KIT DE GUÍAS
KG75-20 BASIC**

código **336***200**



**KIT DE GUÍAS
KG75-30 BASIC**

código **336***300**



**KIT DE GUÍAS
KG75-40 BASIC**

código **336***400**



| | | 2 m | 3 m | 4 m |
|---------------------------|------------|-----|-----|-----|
| longitud | | | | |
| acabados | *** | | | |
| acabado aluminio | | | | |
| lacado blanco | A01 | • | • | • |
| plata mate | A02 | • | • | • |
| oro brillo repulido | A10 | • | • | • |
| chapa sin barnizar | | | | |
| roble s/b | C01 | • | • | • |
| sapelly s/b | C02 | • | • | • |
| fresno s/b | C03 | • | • | • |
| cerezo s/b | C04 | • | • | • |
| haya s/b | C05 | • | • | • |
| pino s/b | C06 | • | • | • |
| haya vaporizada s/b | C07 | • | • | • |
| papel melamina | | | | |
| roble claro A-412 | P02 | • | • | • |
| sapelly D-468 | P03 | • | • | • |
| pino C-419 | P04 | • | • | • |
| cerezo H-450 | P05 | • | • | • |
| haya vaporizada H-428 | P06 | • | • | • |
| roble oscuro A-725 | P07 | • | • | • |
| cerezo tajo H-2428 | P08 | • | • | • |
| wengue congo D-0427 | P09 | • | • | • |
| roble RO R-0444 | P50 | • | • | • |
| blanco W-402 | P84 | • | • | • |

Caja interior autoventa de 1 kit

* Embalaje exterior de 4 kits



**RUEDA SUPERIOR
RODAMIENTO S75**
código 102RODS75



zincado plata
bolsa de 25 unidades
caja de 200 unidades

**RUEDA INFERIOR
Ø60 DIENTE**
cod. 101D60001



zincado plata
caja de 50 unidades

**CARRIL ALTO
CAA75 BASIC**

código 135600***

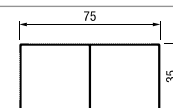
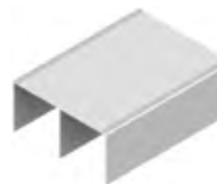

**CARRIL BAJO
CBD75 BASIC**

código 136600***

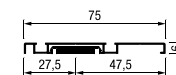

**SUJECCIÓN DE CARRIL
INFERIOR R3
(CPOXX300)**

código 800000016



nylon negro
bolsa de 50 unidades

**FRENO METAL
CARRIL BAJO**







código 804FRE000



acero inox
caja 100 unidades





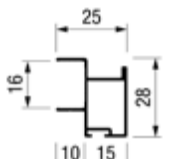
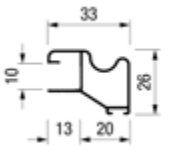
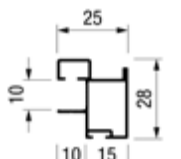
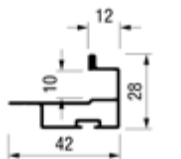



| longitud | | caja de 8 tiras | paquete de 8 tiras |
|-----------------------|-----|-----------------|--------------------|
| embalaje industria | | | |
| cantidad mínima* | | | |
| acabados | *** | | |
| acabado aluminio | | | |
| lacado blanco | A01 | • | • |
| plata mate | A02 | • | • |
| oro brillo repulido | A10 | • | • |
| chapa sin barnizar | | | |
| roble s/b | C01 | • | • |
| sapelly s/b | C02 | • | • |
| fresno s/b | C03 | • | • |
| cerezo s/b | C04 | • | • |
| haya s/b | C05 | • | • |
| pino s/b | C06 | • | • |
| haya vaporizada s/b | C07 | • | • |
| papel melamina | | | |
| roble claro A-412 | P02 | • | • |
| sapelly D-468 | P03 | • | • |
| pino C-419 | P04 | • | • |
| cerezo H-450 | P05 | • | • |
| haya vaporizada H-428 | P06 | • | • |
| roble oscuro A-725 | P07 | • | • |
| cerezo tajo H-2428 | P08 | • | • |
| wengue congo D-0427 | P09 | • | • |
| roble RO R-0444 | P50 | • | • |

* NOTA IMPORTANTE: La medida de 6 metros sólo será servida por paquetes completos y será gestionada como un pedido independiente realizado por transporte especial. Ver condiciones generales de transporte.

| | TIRADOR TR16 BASIC | TIRADOR TR16 MIN BASIC | TIRADOR TR10 BASIC | TIRADOR TR10 MIN BASIC | TIRADOR TR10 V7 BASIC |
|---------------------------|---|--|---|---|---|
| código | 137250*** | 13A250*** | 13B250*** | 13D250*** | 13V250*** |
| |  |  |  |  |  |
| |  |  |  |  |  |
| longitud | 2,5 m | 2,5 m | 2,5 m | 2,5 m | 2,5 m |
| embalaje industria | caja de 20 tiras | caja de 20 tiras | caja de 20 tiras | caja de 20 tiras | caja de 20 tiras |
| cantidad mínima* | | | | | |
| acabados | *** | | | | |
| acabado aluminio | | | | | |
| lacado blanco | A01 | • | • | • | • |
| plata mate | A02 | • | • | • | • |
| oro brillo repulido | A10 | • | | | |
| chapa sin barnizar | | | | | |
| roble s/b | C01 | • | | | |
| sapelly s/b | C02 | • | | | |
| fresno s/b | C03 | • | | | |
| cerezo s/b | C04 | • | | | |
| haya s/b | C05 | • | | | |
| pino s/b | C06 | • | | | |
| haya vaporizada s/b | C07 | • | | | |
| papel melamina | | | | | |
| roble claro A-412 | P02 | • | | | |
| sapelly D-468 | P03 | • | | | |
| pino C-419 | P04 | • | | | |
| cerezo H-450 | P05 | • | | | |
| haya vaporizada H-428 | P06 | • | | | |
| roble oscuro A-725 | P07 | • | | | |
| cerezo tajo H-2428 | P08 | • | | | |
| wengue congo D-0427 | P09 | • | | | |
| roble RO R-0444 | P50 | • | | | |

* **NOTA IMPORTANTE:** Embalaje industria - pedido mínimo, la perfilería de aluminio será suministrada por caja en la cantidad mínima indicada.

**MOLDURAS
S75/S85**

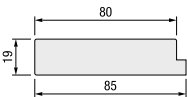
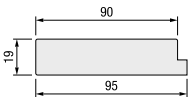
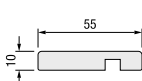
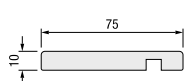
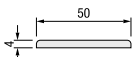
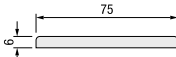
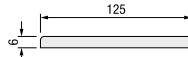
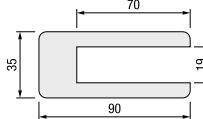
| LATERAL MDF MD8019 | LATERAL MDF MD9019 | TAPAJUNTA MDF MD5510 | TAPAJUNTA MDF MD7510 | MOLDURA TAPETA MD5004 | MOLDURA TAPETA MD7506 | MOLDURA TAPETA MD12506 | MOLDURA EMBOCADURA EMB90 |
|---|---|---|---|---|---|---|---|
| cod. 210270*** | cod. 209270*** | cod. 211270*** | cod. 212270*** | cod. 230360*** | cod. 231360*** | cod. 232360*** | cod. 222270*** 2,7 m cod. 222360*** 3,6 m |
|  |  |  |  |  |  |  |  |
| S75 | S85 | S75 / S85 | S75 / S85 | S75 / S85 | S75 / S85 | S75 / S85 | S75 / S85 |
|  |  |  |  |  |  |  |  |

| | | | | | | | | |
|----------------------------------|---------------|---------------|---------------|---------------|---------------|---------------|---------------|--------------|
| longitud | 2,7 m | 2,7 m | 2,7 m | 2,7 m | 3,6 m | 3,6 m | 3,6 m | 2,7 / 3,6 m |
| embalaje | caja 10 tiras | caja 10 tiras | caja 10 tiras | caja 10 tiras | caja 10 tiras | caja 10 tiras | caja 10 tiras | caja 8 tiras |
| acabados *** | | | | | | | | |
| acabado aluminio | | | | | | | | |
| chapa sin barnizar | | | | | | | | |
| roble s/b C01 | • | • | • | • | • | • | • | • |
| sapelly s/b C02 | • | • | • | • | • | • | • | • |
| fresno s/b C03 | • | • | • | • | • | • | • | • |
| cerezo s/b C04 | • | • | • | • | • | • | • | • |
| haya s/b C05 | • | • | • | • | • | • | • | • |
| pino s/b C06 | • | • | • | • | • | • | • | • |
| haya vaporizada s/b C07 | • | • | • | • | • | • | • | • |
| papel melamina | | | | | | | | |
| roble claro A-412 P02 | • | • | • | • | • | • | • | • |
| sapelly D-468 P03 | • | • | • | • | • | • | • | • |
| pino C-419 P04 | • | • | • | • | • | • | • | • |
| cerezo H-450 P05 | • | • | • | • | • | • | • | • |
| haya vaporizada H-428 P06 | • | • | • | • | • | • | • | • |
| roble oscuro A-725 P07 | • | • | • | • | • | • | • | • |
| cerezo tajo H-2428 P08 | • | • | • | • | • | • | • | • |
| wengue congo D-0427 P09 | • | • | • | • | • | • | • | • |
| blanco W-402 P01 | • | • | • | • | • | • | • | • |
| plata LY-2609 P92 | • | • | • | • | • | • | • | • |



terra

base
floor

SYSKOR
aluminium systems



Foto: Armario empotrado rueda oculta Syskor Base Floor



**KIT DE PUERTA SIMÉTRICA
TR-BASE 25
PARA CARRIL DE 75mm
TABLERO DE 10mm**

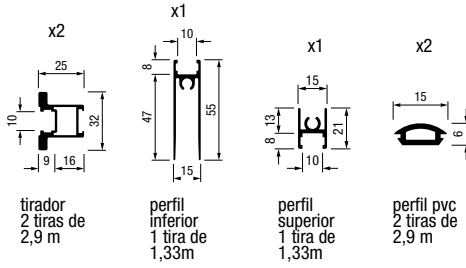

tirador 2 tiras de 2,9 m
perfil inferior 1 tira de 1,33m
perfil superior 1 tira de 1,33m
perfil pvc 2 tiras de 2,9 m



rueda inferior base D40
rueda superior rodamiento base
tornillo M6x30

CÓDIGO 37D290***

| acabados *** | |
|---------------------------------|---|
| lacado blanco A01 | • |
| anodizado plata mate A02 | • |
| anodizado inox mate A12 | • |
| blanco chamonix AM1 | • |
| black mokka AM9 | • |

caja interior autoventa de 1 kit
* embalaje exterior de 4 kits (tablero no incluido)

Lacado Blanco **A01**

RAL 9110 Brillante

Anodizado Plata Mate **A02**

Mate

Anodizado Inox Mate **A12**

Mate

Lacado Blanco Chamonix **AM1**

RAL 9003 Mate texturizado

Lacado Black Mokka **AM9**

RAL 9005 Mate texturizado

**KIT DE PUERTA ASIMÉTRICA
TR-BASE S3
PARA CARRIL DE 75mm
TABLERO DE 10mm**

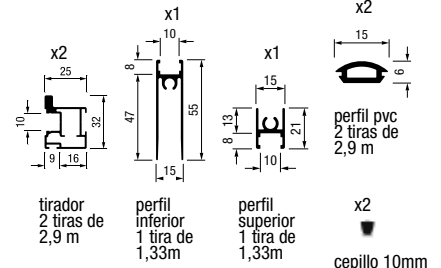

tirador 2 tiras de 2,9 m
perfil inferior 1 tira de 1,33m
perfil superior 1 tira de 1,33m
perfil pvc 2 tiras de 2,9 m
cepillo 10mm negro 2 tiras de 2,9 m



rueda inferior base D40
rueda superior rodamiento base
tornillo M6x30

CÓDIGO 37A290***

| | |
|---------------------------------|---|
| lacado blanco A01 | • |
| anodizado plata mate A02 | • |
| anodizado inox mate A12 | • |
| blanco chamonix AM1 | • |
| black mokka AM9 | • |

**KIT DE GUÍAS
BASE FLOOR**

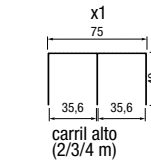

carril alto (2/3/4 m)

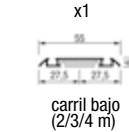

carril bajo (2/3/4 m)

x3 (2/3 m)
x6 (4 m)

sujección de carril inferior R3

CÓDIGO 370*200 370***300 370***400**

| kit 2m | kit 3m | kit 4m |
|--------|--------|--------|
| • | • | • |
| • | • | • |
| • | • | • |
| • | • | • |
| • | • | • |

**KIT PERFIL
CENTRAL "H"
RC BASE**

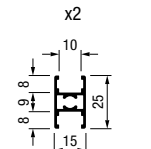

perfil central "h" 2 tiras de 1,33 m



tornillo m6x30

CÓDIGO 37KH75***

| kit 4m |
|--------|
| • |
| • |
| • |
| • |
| • |

**TIRADOR
TR-BASE-S3**

17D290*** 2,9 m

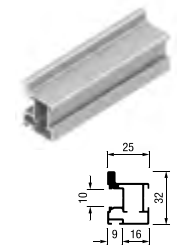

**TIRADOR
TR-BASE25**

17A290*** 2,9 m

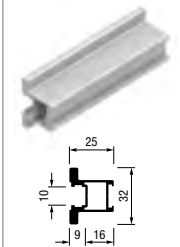

**CARRIL ALTO
CAA75**

110400*** 4 m
110600*** 6 m

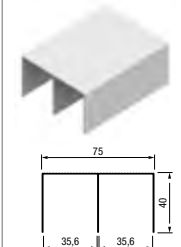

**CARRIL BAJO
CBD55**

11A400*** 4 m
11A600*** 6 m

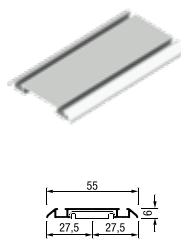

| | | | | |
|---------------------------|-----------------------|-----------------------|----------------------|----------------------|
| longitud | 2,9 m | 2,9 m | 4 m y 6 m | 4 m y 6 m |
| embalaje industria | 1 caja de 16 perfiles | 1 caja de 16 perfiles | 1 caja de 8 perfiles | 1 caja de 8 perfiles |
| cantidad mínima* | | | | |
| acabados | *** | | | |
| lacado blanco | A01 | • | • | • |
| anodizado plata mate | A02 | • | • | • |
| anodizado inox mate | A12 | • | • | • |
| blanco chamonix | AM1 | • | • | • |
| black mokka | AM9 | • | • | • |

**PERFIL INFERIOR "U"
RI-BASE**

cod. 173400***



**PERFIL SUPERIOR
RS-BASE**

cod. 174400***



**PERFIL "H"
DIVISIÓN HORIZONTAL
RC-BASE**

cod. 175400***



| | | | |
|---------------------------|-------------------------|-------------------------|-------------------------|
| longitud | 4 m | 4 m | 4 m |
| embalaje industria | 1 paquete de 8 perfiles | 1 paquete de 8 perfiles | 1 paquete de 8 perfiles |
| cantidad mínima* | | | |
| acabados | *** | | |
| lacado blanco | A01 | • | • |
| anodizado plata mate | A02 | • | • |
| anodizado inox mate | A12 | • | • |
| blanco chamonix | AM1 | • | • |
| black mokka | AM9 | • | • |



Lacado Blanco A01

RAL 9110 Brillante

Anodizado Plata Mate A02

Mate

Anodizado Inox Mate A12

Mate

Lacado Blanco Chamonix AM1

RAL 9003 Mate texturizado

Lacado Black Mokka AM9

RAL 9005 Mate texturizado

**RUEDA SUPERIOR
RODAMIENTO S75**

cod. **170R0DS75**



1 bolsa de 100 unidades

**RUEDA INFERIOR
OCULTA BASE
(Ø40) DIENTE**

cod. **170RIND40**



galvanizado

1 caja de 100 unidades

**TORNILLOS
M6X30**

cod. **170000001**



galvanizado

1 bolsa de 100 unidades

PERFIL LATERAL PVC BASE

cod. **17000300***



pvc



- *GRIS 1
- *BLANCO 2
- *NEGRO 3

1 rollo de 50 m

**PERFIL "V" PARA
CRISTAL BASE
3/4/5/6 mm**

cod. **170005001**



pvc



3 m
caja de 20 tiras de 3 m

**PLANTILLA
TALADROS BASE**

cod. **170000002**



**SUJECCIÓN DE
CARRIL INFERIOR R3
(GPOXX300)**

cod. **800000016**



nylon negro



bolsa de 50 unidades

**FRENO METAL
CARRIL BAJO**

cod. **804FRE000**



acero inoxidable

caja de 100 unidades



**KIT 2 RUEDAS ALTAS CON CIERRE AMORTIGUADO
PARA PUERTA CORREDERA BASE**

| | peso por puerta | |
|---------------------------------------|------------------|--|
| medio cod. 170B75ES2 | de 15 Kg a 40 Kg | |

composición del kit de ruedas Easy Soft:

- 2 ruedas superiores de cierre amortiguado
- 2 activadores
- Tornillería varia

Cajas de 20 kits



**KIT 2 RUEDAS ALTAS + 2 RUEDAS BAJAS
PUERTA CORREDERA BASE**

| código | |
|------------------|--|
| 100B75D40 | |



composición del kit de ruedas:

- 2 ruedas inferiores diente
- 2 ruedas superiores
- Tornillería varia

Cajas de 30 kits



- Nuevo sistema que permite una simplificación máxima en la fabricación del módulo del armario.
- Sistema de guías embutidas con amortiguación integrada (cierre y apertura)
- Peso máximo por puerta: 40 Kg.
- Espesores de puerta: 19-40 mm.
- Anchura máxima de puerta: 1000 mm.
- Altura máxima de puerta: 2400 mm.

Armarios de 2 y 3 puertas

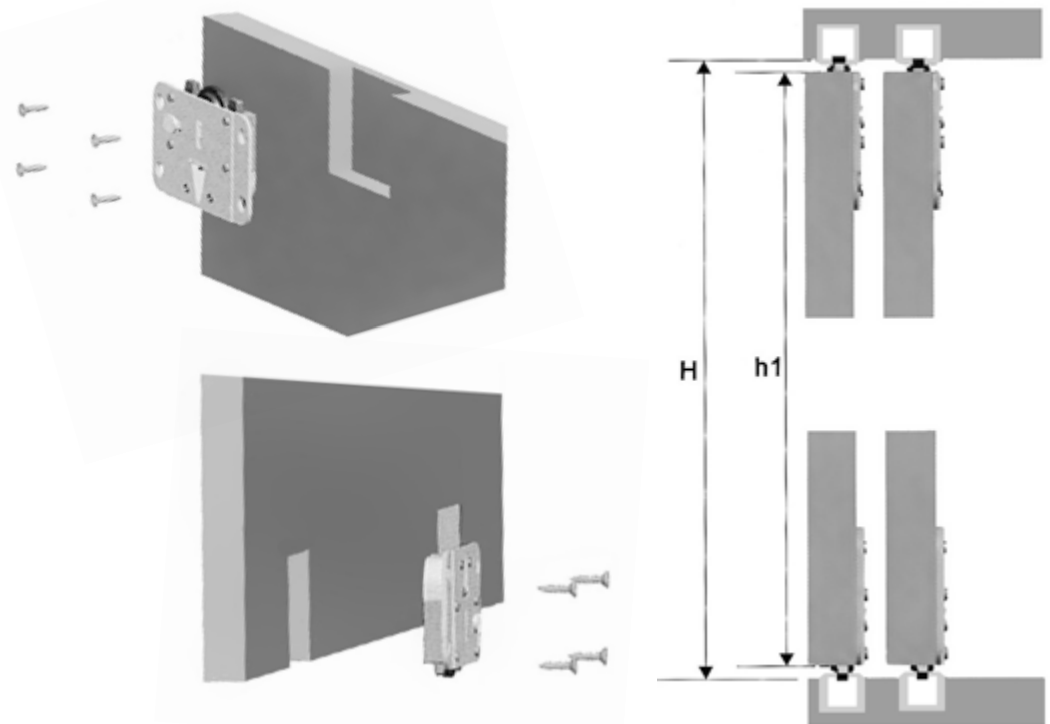
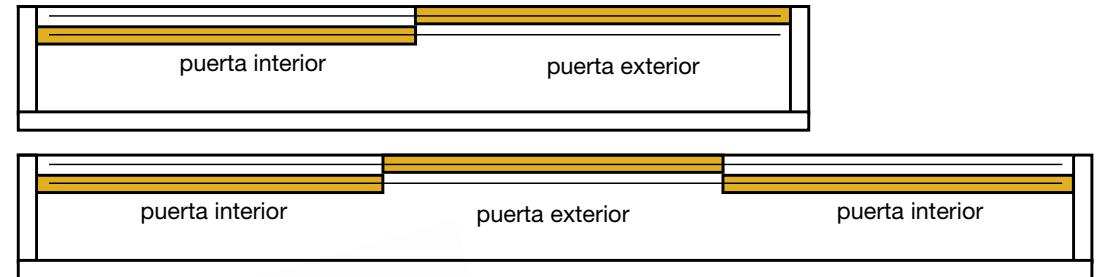



KIT TERRA W40 EASY SOFT DE 8 RUEDAS + 4 CIERRES AMORTIGUADOS PARA 2 PUERTAS DE MADERA
compuesto de:

- 8 ruedas inferiores / superiores
- 4 amortiguaciones
- Tornillos

cod. 100W40000

Embalaje: Caja interior autoventa de 1 kit
Caja exterior de 10 kits

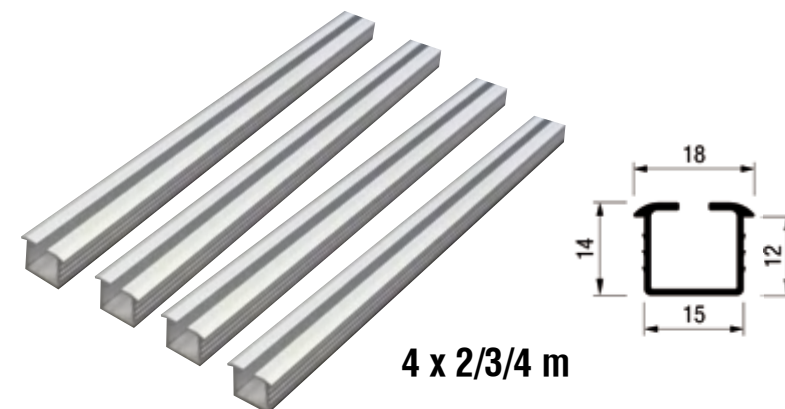
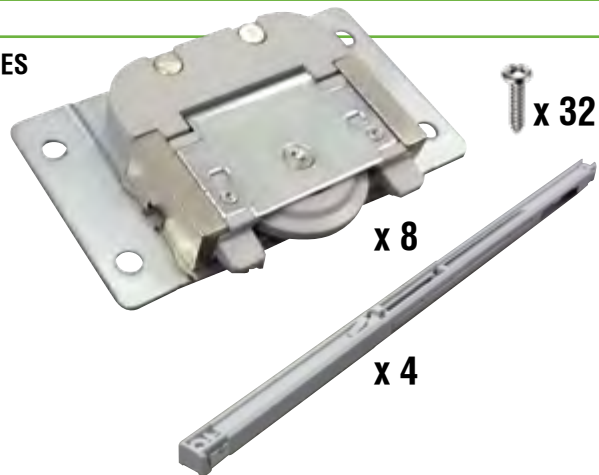

KIT TERRA W40 DE 4 RUEDAS PARA 1 PUERTA DE MADERA
compuesto de:

- 4 ruedas inferiores / superiores
- Tornillos

cod. 100W400SF

Embalaje: Caja interior autoventa de 1 kit
Caja exterior de 20 kits

KIT TERRA W40 DE 4 GUÍAS DE 2/3/4 m
(superiores e inferiores indistintamente)

| longitud | plata mate | | blanco chamonix | | black mokka | |
|----------|------------|---|-----------------|---|--------------|---|
| 2m | 300W40200 | • | 300W40200AM1 | • | 300W40200AM9 | • |
| 3m | 300W40300 | • | 300W40300AM1 | • | 300W40300AM9 | • |
| 4m | 300W40400 | • | 300W40400AM1 | • | 300W40400AM9 | • |

Caja interior autoventa de 1 kit
* Embalaje exterior de 4 kits

Anodizado A02
Plata Mate

Mate

Lacado AM1
Blanco Chamonix

RAL 9003 Mate texturizado

Lacado AM9
Black Mokka

RAL 9005 Mate texturizado



Puertas colgantes de paso

5

SYSKOR
aluminium systems

SYSKOR
aluminium systems



Foto: Vestidor con puertas correderas Air M60 con cierre amortiguado en acabado Blanco Chamonix

Puertas colgantes de paso Air

Kits de rodaduras Air



Kits de carriles / embellecedores Air



Kits de puertas de aluminio Base Air



Embalaje industria carriles Air



Embalaje industria puertas Base Air

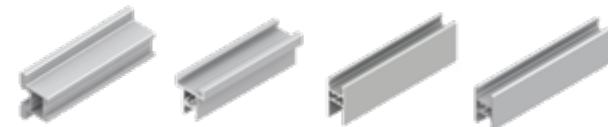

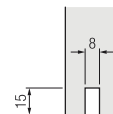
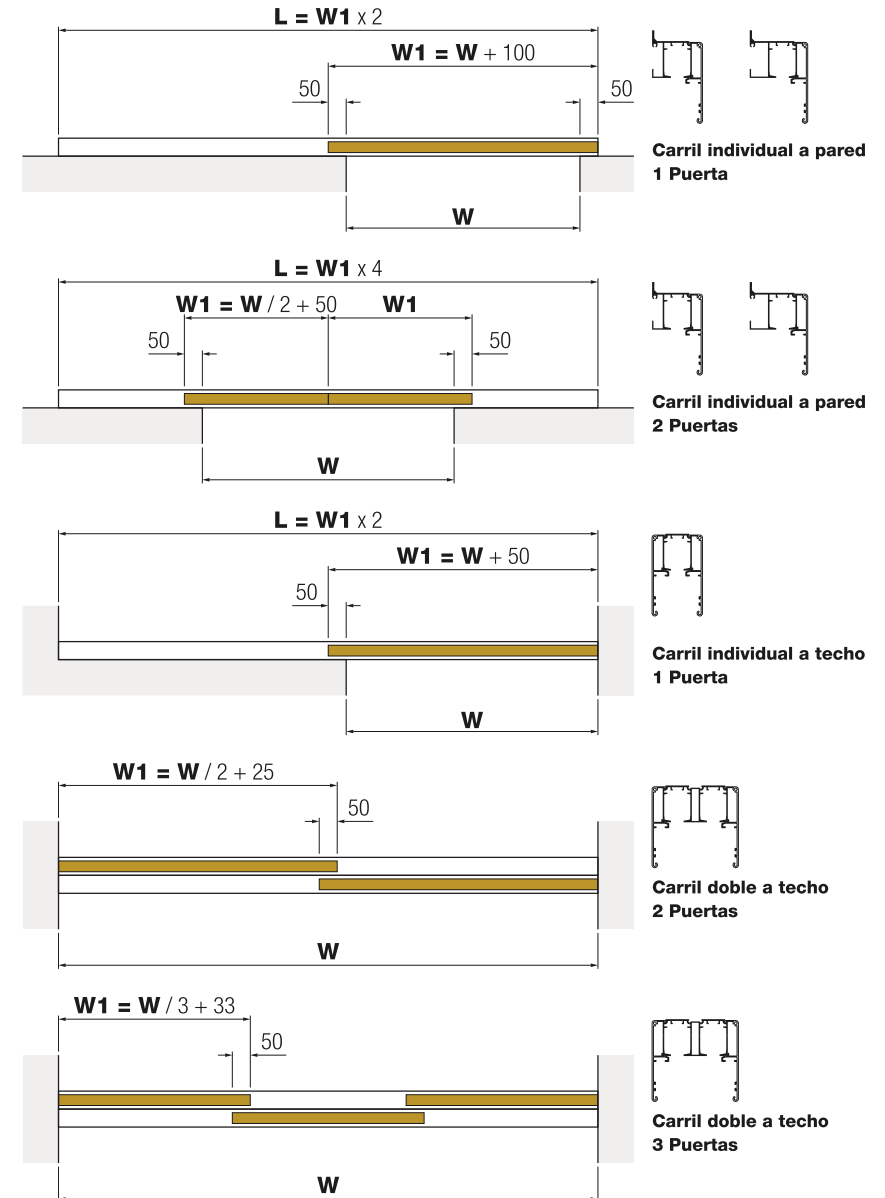
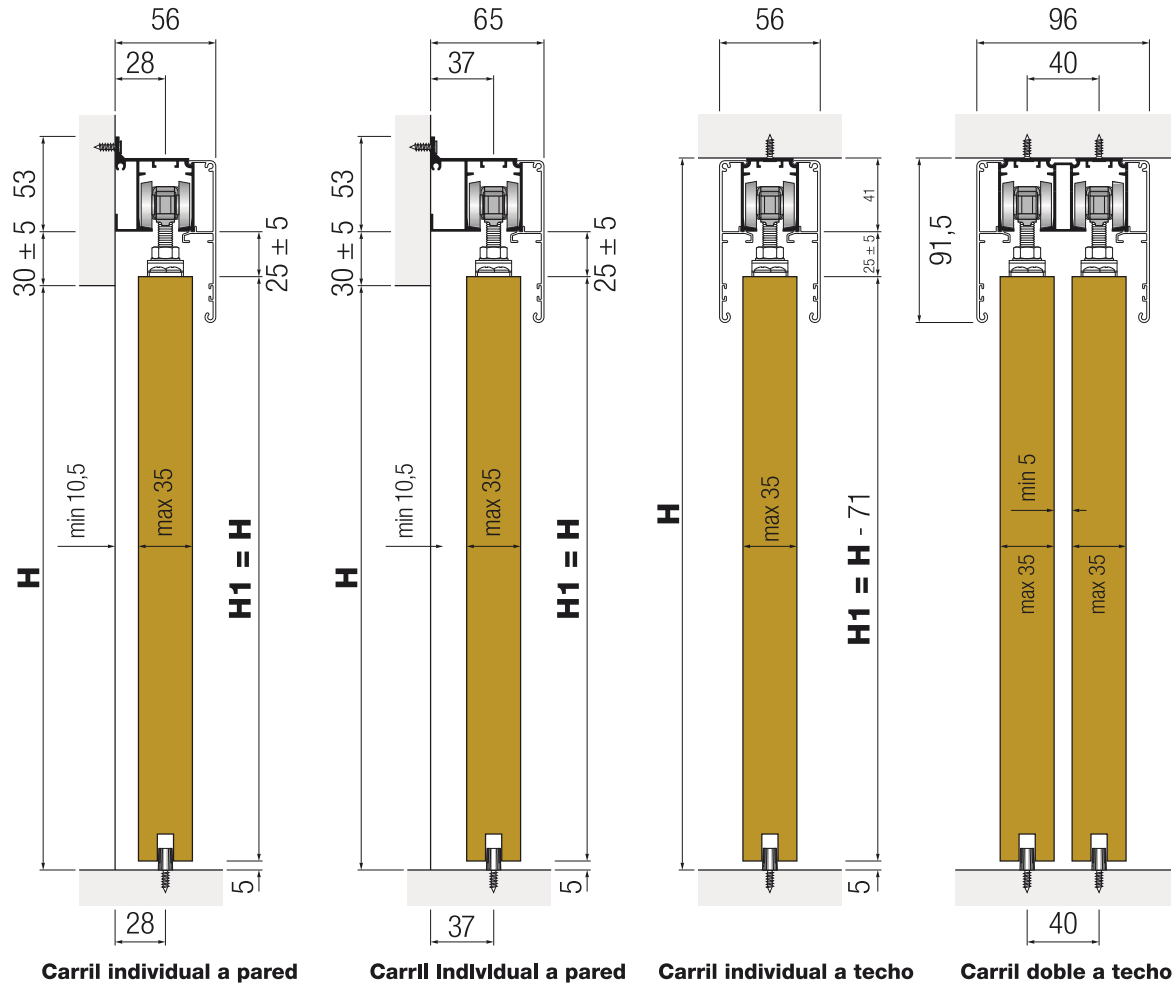



carril individual a pared

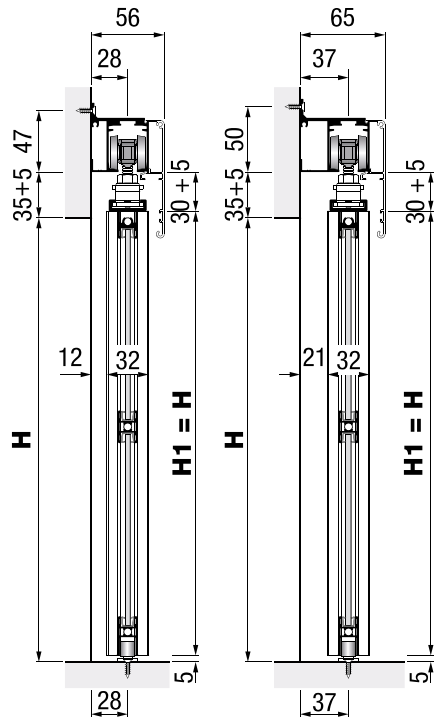

carril individual y doble a techo

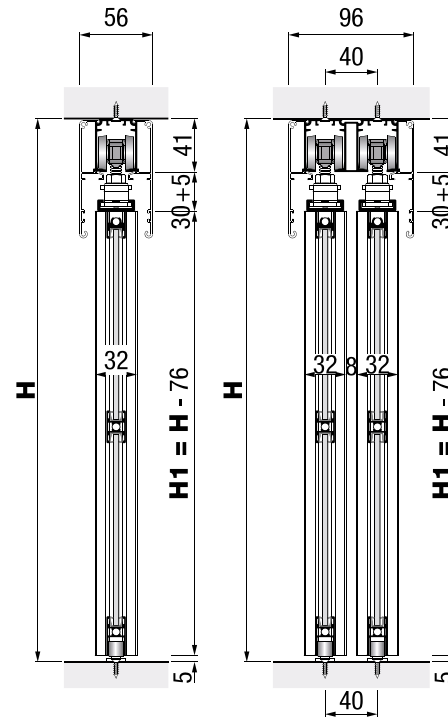

Air M60 Easy soft Puertas colgantes de paso apertura y cierre amortiguado

Sistemas **Air M60** y **Air M60 Easy soft** con apertura y cierre amortiguados para **puertas correderas de paso**.

- Rodaduras de bolas de alta precisión para un funcionamiento suave, silencioso y duradero.
- **Versiones** con apertura y cierres amortiguados "Easy soft".
- Para puertas de madera de hasta **35mm de espesor**
- Peso máximo de puerta: **60 kgs**
- Anchura máxima de puerta: **1200 mm**
- Altura máxima de puerta: **2500 mm**
- Versiones para **puertas de aluminio Air Base** en tablero / cristal

KIT 2 CARROS PUERTA COLGANTE DE PASO AIR M60 EASY SOFT CON APERTURA Y CIERRE AMORTIGUADOS cod. 170102M60

para puertas de hasta 60 Kgs

embalaje: caja interior autoventa 1 kit
caja exterior de 20 kits



Air M60
Puertas colgantes de paso

KIT RODADURA AIR M60 PARA PUERTAS DE MADERA
cod. 170100M60

para puertas de hasta 60 Kgs
embalaje: caja interior autoventa 1 kit
caja exterior de 50 kits

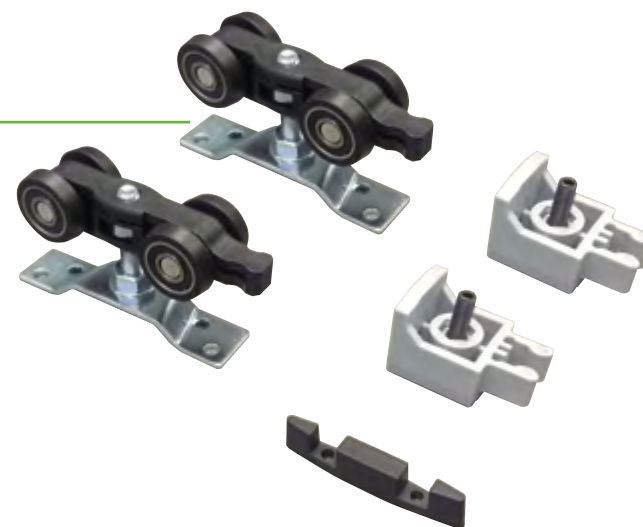

PERFIL PVC LATERAL

cod. gris **170003001**
cod. blanco **170003002**
cod. negro **170003003**



pvc

1 rollo de 50 m

**PERFIL
ACRISTALAMIENTO
"V" 3/4/5/6 mm**

cod. **170005001**



pvc rígido transparente



caja de 20 tiras de 3 m

**PLANTILLA
MANUAL BASE**

cod. **170000002**



TORNILLO M6X30

cod. **170000001**



galvanizado

1 bolsa de 100 unidades

**KIT DE 2 PLETINAS Y GUÍA INFERIOR AIR M60
PARA PUERTAS COLGANTES DE ALUMINIO
BASE AIR**

cod. **170ALUM60**



1 bolsa de 50 unidades

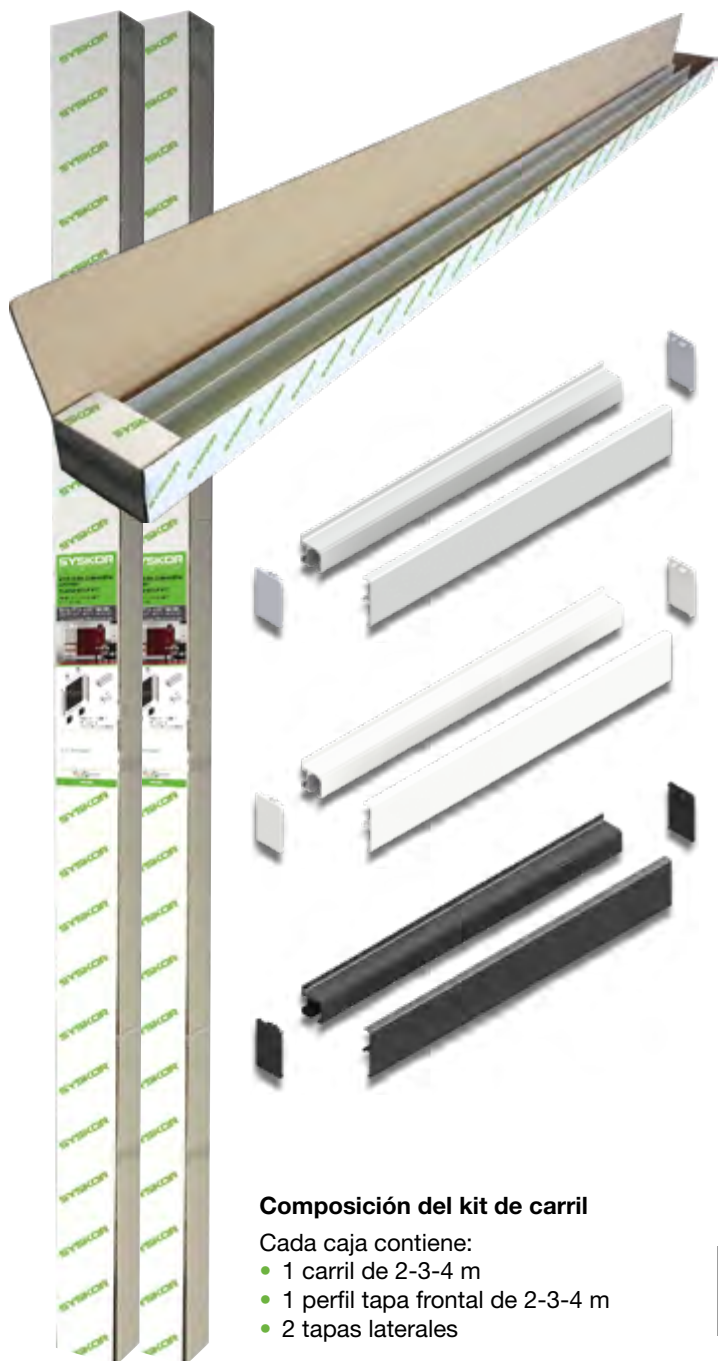

KIT CARRIL INDIVIDUAL A PARED Z10 AIR M60

Kit de 1 carril alto, 1 perfil tapa-embellecedor frontal y 2 tapas laterales

* Kit para pared con zócalo de hasta 10 mm

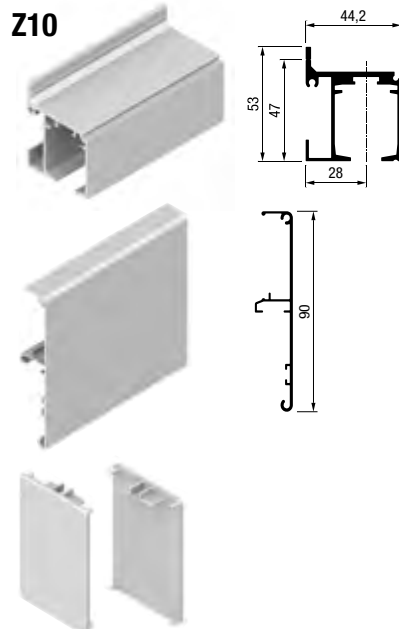

| cod. | 17K262*** kit 2m | 17K263*** kit 3m | 17K264*** kit 4m |
|--------------------------|---------------------|---------------------|---------------------|
| acabados *** | | | |
| anodizado plata mate A02 | • | • | • |
| blanco chamonix AM1 | • | • | • |
| black mokka AM9 | • | • | • |

caja interior autoventa de 1 kit
* embalaje exterior de 4 kits

Anodizado A02
Plata Mate

Mate



Lacado AM1
Blanco Chamonix

RAL 9003 Mate texturizado



Lacado AM9
Black Mokka

RAL 9005 Mate texturizado



KIT CARRIL INDIVIDUAL A PARED Z16 AIR M60

Kit de 1 carril alto, 1 perfil tapa-embellecedor frontal y 2 tapas laterales

* Kit para pared con zócalo de hasta 16 mm

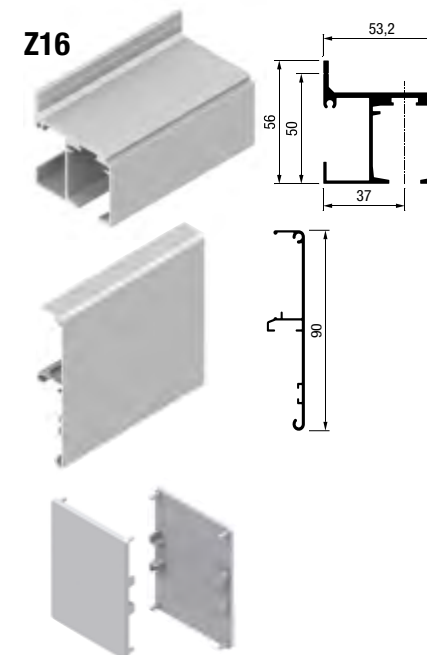

| cod. | 17K272*** kit 2m | 17K273*** kit 3m | 17K274*** kit 4m |
|--------------------------|---------------------|---------------------|---------------------|
| acabados *** | | | |
| anodizado plata mate A02 | • | • | • |
| blanco chamonix AM1 | • | • | • |
| black mokka AM9 | • | • | • |

caja interior autoventa de 1 kit
* embalaje exterior de 4 kits

Composición del kit de carril

Cada caja contiene:

- 1 carril de 2-3-4 m
- 1 perfil tapa frontal de 2-3-4 m
- 2 tapas laterales

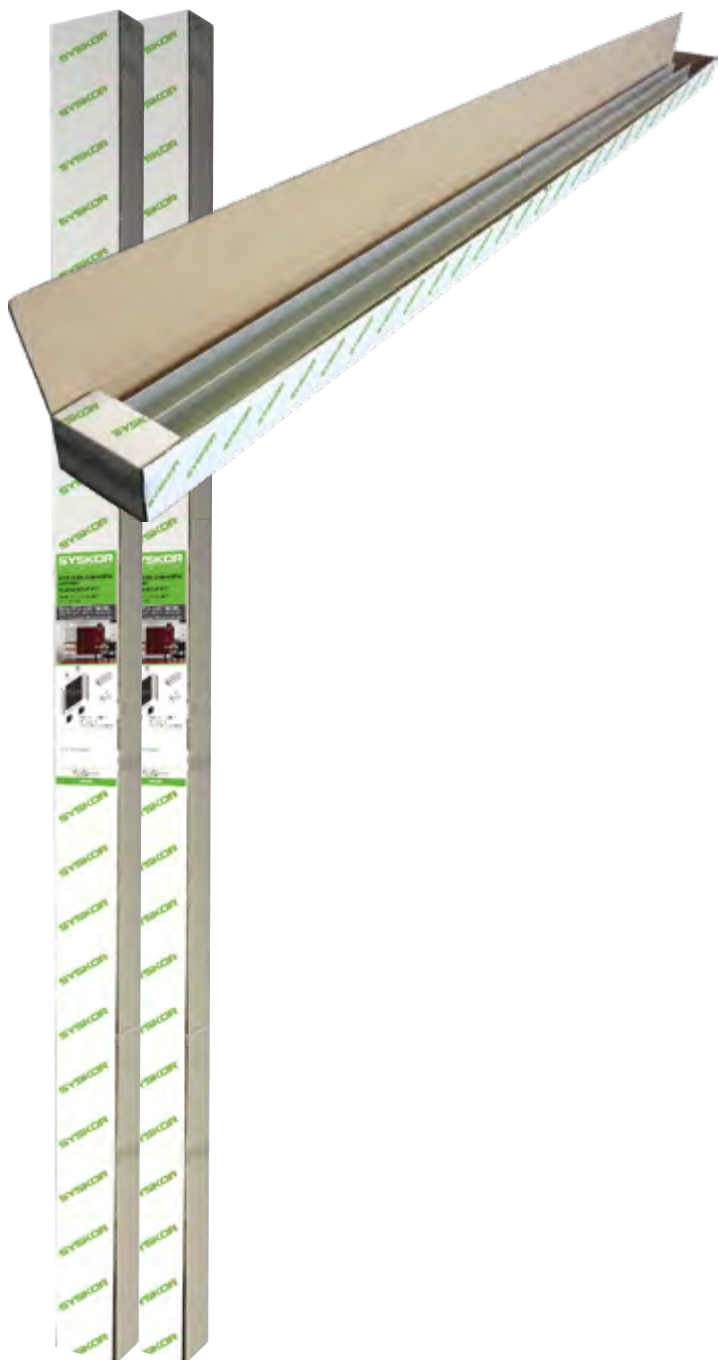

KIT CARRIL INDIVIDUAL A TECHO

Kit de 1 carril individual a techo 2-3-4 metros

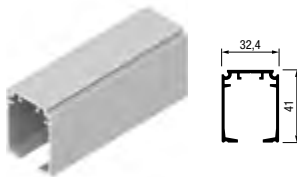

| cod. | 17K202*** kit 2m | 17K203*** kit 3m | 17K204*** kit 4m |
|--------------------------|---------------------|---------------------|---------------------|
| acabados *** | | | |
| anodizado plata mate A02 | • | • | • |
| blanco chamonix AM1 | • | • | • |
| black mokka AM9 | • | • | • |

caja interior autoventa de 1 kit
* embalaje exterior de 4 kits

KIT CARRIL DOBLE A TECHO

Kit de 1 carril doble a techo 2-3-4 metros

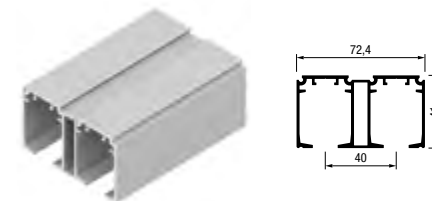

| cod. | 17K222A02 kit 2m | 17K223A02 kit 3m | 17K224A02 kit 4m |
|--------------------------|---------------------|---------------------|---------------------|
| acabados *** | | | |
| anodizado plata mate A02 | • | • | • |

caja interior autoventa de 1 kit
* embalaje exterior de 4 kits

KIT TAPA FRONTAL

Kit de 1 tapa frontal 2-3-4 metros

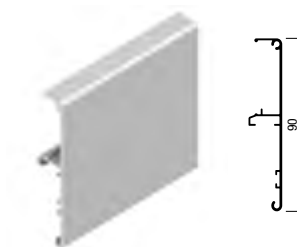

| cod. | 17K232*** kit 2m | 17K233*** kit 3m | 17K234*** kit 4m |
|--------------------------|---------------------|---------------------|---------------------|
| acabados *** | | | |
| anodizado plata mate A02 | • | • | • |
| blanco chamonix AM1 | • | • | • |
| black mokka AM9 | • | • | • |

caja interior autoventa de 1 kit
* embalaje exterior de 4 kits

Anodizado A02
Plata Mate

Mate

Lacado AM1
Blanco Chamonix

RAL 9003 Mate texturizado

Lacado AM9
Black Mokka

RAL 9005 Mate texturizado



Anodizado A02
Plata Mate

Mate



Lacado AM1
Blanco Chamonix

RAL 9003 Mate texturizado



Lacado AM9
Black Mokka

RAL 9005 Mate texturizado

Foto: Puerta colgante de aluminio Base Air Syskor con cierre amortiguado en acabado Black Mokka

KIT DE 1 PUERTA DE ALUMINIO BASE AIR

Kit de 1 puerta de hasta 2,9 m x 1,33 m para tablero de 10 mm

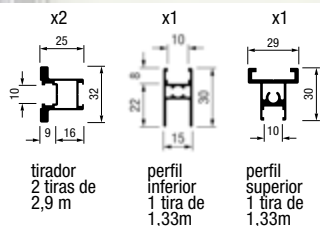

Acabado Anodizado Plata Mate
cod. 17K29A02

Anodizado A02
Plata Mate

Mate

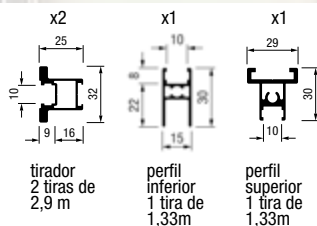

Acabado Blanco Chamonix
cod. 17K29AM1

Lacado AM1
Blanco Chamonix

RAL 9003 Mate texturizado

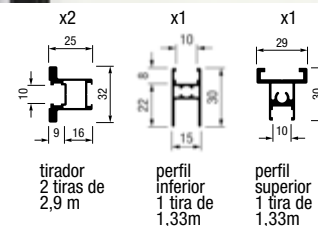

Acabado Black Mokka
cod. 17K29AM9

Lacado AM9
Black Mokka

RAL 9005 Mate texturizado

Composición del kit de puerta

- 2 perfiles tiradores (2 x 2,9 m)
- 1 perfil horizontal superior (1 x 1,33 m)
- 1 perfil horizontal inferior (1 x 1,33 m)
- 2 pletinas de fijación
- Perfil paragolpes lateral PVC (2 x 2,9 m)
- 1 guía inferior
- Tornillería varia

* Tablero no incluido

caja interior autoventa de 1 kit

* embalaje exterior de 4 kits (tablero no incluido)

KIT PERFIL CENTRAL "H" RC BASE

Kit de 2 perfiles japonesa de 1,33 m

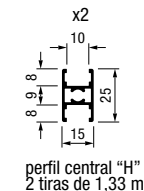

| acabados | código | |
|----------------------|------------------|---|
| anodizado plata mate | 37KH75A02 | • |
| blanco chamonix | 37KH75AM1 | • |
| black mokka | 37KH75AM9 | • |



**CARRILES
EMBALAJE
INDUSTRIA**

**CARRIL INDIVIDUAL A
PARED ZÓCALO 10mm**
170214*** 4 m

Z10



1 caja de 8 perfiles

**CARRIL INDIVIDUAL A
PARED ZÓCALO 16mm**
170254*** 4 m

Z16



1 caja de 8 perfiles

**CARRIL INDIVIDUAL
A TECHO**
170204*** 4 m



1 caja de 8 perfiles

**CARRIL DOBLE
A TECHO**
170224A02 4 m

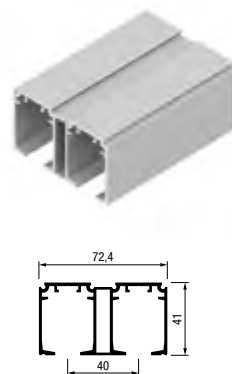

1 caja de 8 perfiles

TAPA FRONTAL
170234*** 4 m



1 caja de 8 perfiles

embalaje industria

| acabados | *** |
|----------------------|------------|
| acabado aluminio | |
| anodizado plata mate | A02 |
| blanco chamonix | AM1 |
| black mokka | AM9 |

| | |
|--|---|
| | • |
| | • |
| | • |

| | |
|--|---|
| | • |
| | • |
| | • |

| | |
|--|---|
| | • |
| | • |
| | • |

| | |
|--|---|
| | • |
| | • |
| | • |

| | |
|--|---|
| | • |
| | • |
| | • |

**TAPA LATERAL CARRIL
Z10 (ZÓCALO 10mm)**



nylon gris
nylon blanco
nylon black mokka

**TAPA LATERAL CARRIL
Z16 (ZÓCALO 16mm)**



nylon gris
nylon blanco
nylon black mokka

| 1 caja de 20 unidades | |
|-----------------------|----------|
| cod. | acabados |
| 170200000 | gris • |
| 170200AM1 | blanco • |
| 170200AM9 | negro • |

| 1 caja de 20 unidades | |
|-----------------------|----------|
| cod. | acabados |
| 170200Z16 | gris • |
| 1702Z16AM1 | blanco • |
| 1702Z16AM9 | negro • |

* Pedido mínimo embalaje industria:
1 caja de cada referencia

**PUERTA
ALUMINIO
EMBALAJE
INDUSTRIA**

**TIRADOR
TR-BASE25**

17A290*** 2,9 m

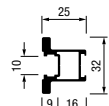

**PERFIL SUPERIOR
RS-BASE TOP**

cod. 178400***

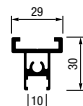

**PERFIL INFERIOR
RI-BASE**

cod. 179400***



**PERFIL CENTRAL
RC-BASE
"H" HORIZONTAL**

cod. 175400***

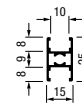

| | |
|----------------------|-----------------------|
| longitud | 2,9 m |
| embalaje | 1 caja de 16 perfiles |
| acabados | *** |
| acabado aluminio | |
| anodizado plata mate | A02 |
| blanco chamonix | AM1 |
| black mokka | AM9 |

| | |
|--|---|
| | • |
| | • |
| | • |

| | |
|--|---|
| | • |
| | • |
| | • |

| | |
|--|---|
| | • |
| | • |
| | • |

Anodizado **A02**
Plata Mate
Mate

Lacado **AM1**
Blanco Chamonix
RAL 9003 Mate texturizado

Lacado **AM9**
Black Mokka
RAL 9005 Mate texturizado

SYSKOR

aluminium systems



Foto: Vestidor con barras de colgar e iluminación leds - Syskor

Interiorismo para armarios

6

SYSKOR
aluminium systems

SYSKOR

kitchen & home fittings

Modern

Style

Organize



wardrobes storage

wardrobes organization & storage

Zapateros, pantaloneros extraíbles, espejos, cestas y accesorios para mantener el armario ordenado y con un máximo aprovechamiento del espacio disponible.

Sistemas Kit de estantes de aluminio para vestidores, almacenes y tiendas.

MOKKA line

Accesorios «Premium» para armario con cierre «easy soft».





ELEVADOR GUARDARROPA CIERRE AMORTIGUADO ACABADO MOKA

Cod. 4MK201A15 ancho 60 - 83 cm

Cod. 4MK202A15 ancho 83 - 115 cm

Caja monocolor de 1 unidad
Embalaje exterior 6 unidades

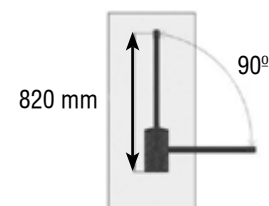
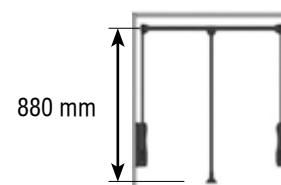



ESPEJO EXTRAÍBLE CIERRE AMORTIGUADO ACABADO MOKA

Cod. 4MK203A15

Dimensiones: ancho 475 mm x alto 1130 mm

Caja monocolor de 1 unidad

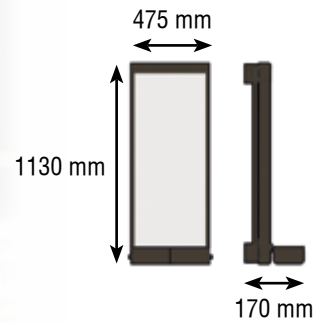

PERCHERO EXTRAÍBLE CIERRE AMORTIGUADO ACABADO MOKA

Cod. 4MK204A15

Dimensiones: ancho 85 mm x alto 160 mm x profundidad 445 mm

Caja monocolor de 1 unidad

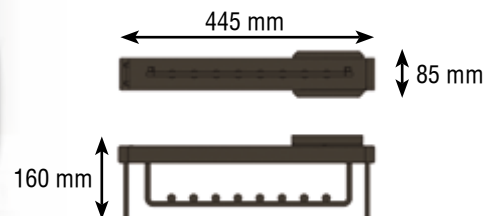



acabado moka / crema

JOYERO EXTRAIBLE CON CIERRE AMORTIGUADO ACABADO MOKA

| código | descripción | anchura módulo | dimensiones (ancho x fondo x alto) |
|-----------|----------------------|----------------|---------------------------------------|
| 4MK010600 | joyero extraible 600 | 600 mm | 564 / 614 x 475 x 70 mm |
| 4MK010800 | joyero extraible 800 | 800 mm | 764 / 814 x 475 x 70 mm |
| 4MK010900 | joyero extraible 900 | 900 mm | 864 / 914 x 475 x 70 mm |

guías ocultas 450 mm con amortiguación incluidas

Caja monocolor de 1 unidad

PANTALONERO EXTRAIBLE CON CIERRE AMORTIGUADO ACABADO MOKA

| código | descripción | anchura módulo | dimensiones (ancho x fondo x alto) |
|-----------|--|----------------|---------------------------------------|
| 4MK020600 | pantalonero extraible 600 8 pantalones | 600 mm | 564 / 614 x 475 x 60 mm |
| 4MK020800 | pantalonero extraible 800 12 pantalones | 800 mm | 764 / 814 x 475 x 60 mm |
| 4MK020900 | pantalonero extraible 900 14 pantalones | 900 mm | 864 / 914 x 475 x 60 mm |

guías ocultas 450 mm con amortiguación incluidas

Caja monocolor de 1 unidad



acabado moka

barras con goma antideslizante



acabado moka

Caja monocolor de 1 unidad

ZAPATERO EXTRAIBLE CON CIERRE AMORTIGUADO ACABADO MOKA

| código | descripción | anchura módulo | dimensiones (ancho x fondo x alto) |
|-----------|------------------------|----------------|---------------------------------------|
| 4MK030600 | zapatero extraible 600 | 600 mm | 564 / 614 x 475 x 180 mm |
| 4MK030800 | zapatero extraible 800 | 800 mm | 764 / 814 x 475 x 180 mm |
| 4MK030900 | zapatero extraible 900 | 900 mm | 864 / 914 x 475 x 180 mm |

guías ocultas 450 mm con amortiguación incluidas

CESTO EXTRAIBLE CON CIERRE AMORTIGUADO ACABADO MOKA

| código | descripción | anchura módulo | dimensiones (ancho x fondo x alto) |
|-----------|---------------------|----------------|---------------------------------------|
| 4MK040600 | cesto extraible 600 | 600 mm | 564 / 614 x 475 x 140 mm |
| 4MK040800 | cesto extraible 800 | 800 mm | 764 / 814 x 475 x 140 mm |
| 4MK040900 | cesto extraible 900 | 900 mm | 864 / 914 x 475 x 140 mm |

guías ocultas 450 mm con amortiguación incluidas



acabado moka

Caja monocolor de 1 unidad



**JUEGO DE 2 SOPORTES PARA COSTADO
BARRA DE COLGAR MINIMALISTA**

| código | acabado |
|-----------|--------------------|
| 4MK102A02 | aluminio anodizado |
| 4MK102A15 | aluminio moka |
| 4MK102A09 | aluminio negro |

Bolsa de 1 juego / Caja de 25 juegos



**JUEGO DE 2 SOPORTES LATERALES A TECHO
CON TORNILLOS PARA BARRA DE COLGAR MINIMALISTA**

| código | acabado |
|-----------|--------------------|
| 4MK101A02 | aluminio anodizado |
| 4MK101A15 | aluminio moka |
| 4MK101A09 | aluminio negro |

Bolsa de 1 juego / Caja de 25 juegos



BARRA DE COLGAR MINIMALISTA CON GOMA

| código | longitud | acabado |
|-----------|----------|--------------------|
| 4MK100A02 | 3 m | aluminio anodizado |
| 4MK100A15 | 3 m | aluminio moka |
| 4MK100A09 | 3 m | aluminio negro |

Caja de 10 tiras

Aluminio
anodizado

Aluminio
moka

Aluminio
negro



PANTALONERO FRONTAL EXTRAIBLE CON GOMA ANTIDESLIZANTE. 5 PANTALONES

Cod. 8AC201000

Ancho x fondo x alto = 20 x 35 x 10 cm.
Caja color 1 unidad
Embalaje exterior de 10 cajas unitarias



PANTALONERO FRONTAL EXTRAIBLE CON GOMA ANTIDESLIZANTE. 10 PANTALONES

Cod. 8AC202000

Ancho x fondo x alto = 40 x 35 x 10 cm.
Caja color 1 unidad
Embalaje exterior de 4 cajas unitarias



PANTALONERO LATERAL EXTRAIBLE CON GOMA ANTIDESLIZANTE. 11 PANTALONES

Cod. 8AC203000

Ancho x fondo x alto = 34,5 x 46,5 x 9 cm.
Caja color 1 unidad
Embalaje exterior de 4 cajas unitarias



PANTALONERO LATERAL EXTRAIBLE. 20 PANTALONES

Cod. 8AC204000

Ancho x fondo x alto = 69 x 47,5 x 8,5 cm.
Caja color 1 unidad
Embalaje exterior de 4 cajas unitarias



zapatero extraíble con caja a color autoventa

ZAPATERO FRONTAL EXTRAÍBLE

Cod. 8AC303000 ancho 30 / 45 cm

Cod. 8AC302000 ancho 46 / 80 cm

Cod. 8AC301000 ancho 56 / 100 cm

Fondo x alto = 45 x 15 cm.

Caja color 1 unidad

Embalaje exterior de 4 cajas unitarias



Escuadras para frente de cajón incluidas





ELEVADOR GUARDARROPA GRIS / PLATA

Cod. 404001992 ancho 45 / 60 cm

Cod. 404002002 ancho 60 / 83 cm

Cod. 404003002 ancho 83 / 115 cm



ESPEJO EXTRAIBLE ABATIBLE PLATA

Cod. 404050000

Ancho x alto = 34 x 100 cm.
Caja monocolor 1 unidad



ELEVADOR GUARDARROPA NEGRO / CROMO

Cod. 404001999 ancho 45 / 60 cm

Cod. 404002000 ancho 60 / 83 cm

Cod. 404003000 ancho 83 / 115 cm

Fondo x alto = 14 x 85 cm.
Caja monocolor 1 unidad
Embalaje exterior de 6 cajas unitarias



TUBO OVALADO BARRA DE COLGAR 30 x 15

Cod. 105ECOAO2 plata mate

Tiras de 4 metros
Caja de 25 tiras



SOPORTE LATERAL BARRA DE COLGAR PLATA 30 x 15

Cod. 805SPLA02

Caja de 100 unidades



SOPORTE CENTRAL BARRA DE COLGAR PLATA 30 x 15

Cod. 805SPCA02

Caja de 50 unidades



HERRAJE DE UNIÓN ANGULAR

código 40500200*



plástico

caja de 1.000 unidades

HERRAJE DE UNIÓN COSTADO Y TRASERA

código 405001000



plástico

bolsa de 50 unidades
caja de 500 unidades

SOPORTE PARA FONDOS

código 405003000



plástico transparente

caja de 1.000 unidades

PATA NIVELADORA ARMARIO

código 805PTN000



zincado plata

caja de 100 unidades

acabados *

blanco 1

marrón 3

beige 8

**PANTALONERO LATERAL EXTRAIBLE BÁSICO
CON GOMA ANTIDESLIZANTE 11 PANTALONES**

Cod. 402002000

Ancho x fondo x alto = 34 x 46 x 15 cm.
Caja monocolor de 1 unidad
Embalaje de 6 cajas unitarias



PERCHERO EXTRAIBLE

Cod. 8AC502000 ancho x fondo x alto 14 x 30 x 9 cm

Cod. 8AC503000 ancho x fondo x alto 14 x 36 x 9 cm

Cod. 8AC504000 ancho x fondo x alto 14 x 42 x 9 cm

Caja monocolor de 1 unidad
Embalaje de 10 cajas unitarias



**PANTALONERO LATERAL EXTRAIBLE BÁSICO
CON GOMA ANTIDESLIZANTE 9 PANTALONES**

Cod. 402001000

Ancho x fondo x alto = 34 x 38,5 x 15 cm.
Caja monocolor de 1 unidad
Embalaje de 6 cajas unitarias

PERCHERO PARED ABATIBLE METÁLICO

Cod. 8AC501000

Ancho x alto = 41 x 7,5 cm.
Caja monocolor de 1 unidad
Embalaje de 20 cajas unitarias

EMPUJAMANGAS

Cod. 8AC002000

Ancho x alto = 29 x 11,5 cm.
Caja monocolor de 1 unidad
Embalaje de 10 cajas unitarias

CORBATERO EXTRAIBLE METÁLICO

Cod. 8AC101000

Ancho x fondo = 13 x 44 cm.
Caja monocolor de 1 unidad
Embalaje de 10 cajas unitarias

CORBATERO CINTURONERO FIJO

Cod. 8AC102000

Ancho x fondo = 4 x 40 cm.
Caja monocolor de 1 unidad
Embalaje de 28 cajas unitarias



SYSKOR

aluminium systems



Foto: Sistema de estanterías de aluminio Spot de Syskor

SYSKOR

aluminium systems



Foto: Programa modular de estanterías de aluminio Spot - Syskor

Estanterías de aluminio

7

SYSKOR
aluminium systems



KIT SPOT PROFILE

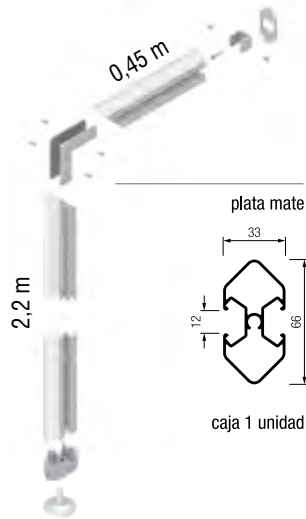

KIT PERFIL SPOT 1 UNIDAD CORTADA A INGLETE
código **181001A02**

kit compuesto de:
A 1 perfil spot (2,2 m)
B 1 perfil spot (0,45 m)
(corte en inglete + roscado)

C 1 soporte pared spot
D 2 escuadras unión
E 1 pata
F 1 tapa roscada + tornillos



KIT PERFIL SPOT 8 UNIDADES

código **181100A02**

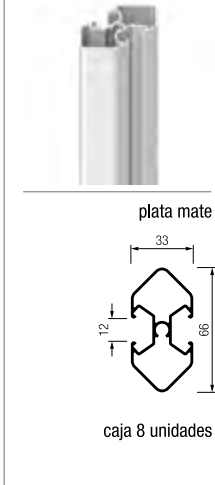

kit compuesto de:
A 8 perfiles spot (2,7 m)
(corte recto + roscado)

C 8 soportes pared spot
D 16 escuadras unión
E 8 pata
F 8 tapa roscada + tornillos

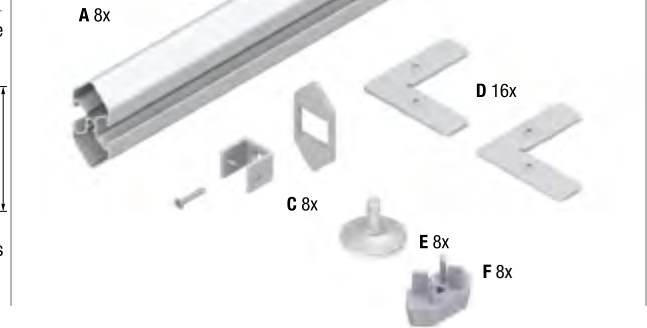

KIT QUADRO PROFILE

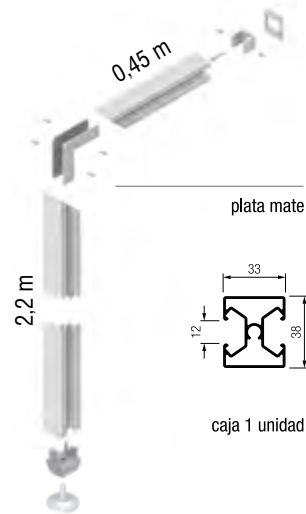

KIT PERFIL QUADRO 1 UNIDAD CORTADA A INGLETE
código **182001A02**

kit compuesto de:
A 1 perfil quadro (2,2 m)
B 1 perfil quadro (0,45 m)
(corte en inglete + roscado)

C 1 soporte pared quadro
D 2 escuadras unión
E 1 pata
F 1 tapa roscada + tornillos



KIT PERFIL QUADRO 8 UNIDADES

código **182100A02**

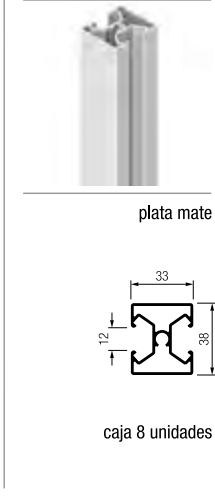

kit compuesto de:
A 8 perfiles quadro (2,7 m)
(corte recto + roscado)

C 8 soportes pared quadro
D 16 escuadras unión
E 8 pata
F 8 tapa roscada + tornillos



KIT ESCUADRA UNIÓN

código **180001000**



zincado plata

bolsa 2 escuadras
 + tornillos
 Caja de 100 kits

TAPA ROSCADA SPOT

código **180005000**



color gris

Caja de 100 unidades

TAPA ROSCADA QUADRO

código **180006000**



color gris

Caja de 100 unidades

PATA SPOT - QUADRO

código **180002000**



zincado plata

bolsa 1 pata
 Caja de 100 unidades

KIT SOPORTE PARED SPOT

código **180003000**



zincado plata
 plástico gris

bolsa 1 soporte
 + embellecedor
 + tornillos
 Caja de 100 kits

KIT SOPORTE PARED QUADRO

código **180004000**



zincado plata
 plástico gris

bolsa 1 soporte
 + embellecedor
 + tornillos
 Caja de 100 kits

KIT SOPORTE BALDA CLASSIC INCLINABLE

código **180101000**



gris

caja 2 soportes
 + fijaciones
 + tornillos
 Caja de 20 kits

KIT SOPORTE BALDA CLASSIC FIJA FIJACIÓN FRONTAL DIRECTA

código **180102000**



gris

caja 2 soportes
 + fijaciones
 + tornillos
 Caja de 20 kits

KIT SOPORTE BALDA MINI FIJA

código **180103000**



gris

caja 2 soportes
 + fijaciones
 + tornillos
 Caja de 20 kits

KIT SOPORTE BALDA MINI FIJA FIJACIÓN FRONTAL DIRECTA

código **180104000**



gris

caja 2 soportes
 + fijaciones
 + tornillos
 Caja de 20 kits

KIT SOPORTE BALDA MORDAZA FIJACIÓN FRONTAL DIRECTA

código **180105000**



gris

bolsa 2 soportes
 + fijaciones
 + tornillos
 Caja de 100 kits

RUEDA SIN FRENO TRANSPARENTE 75 mm

código **180201000**



transparente

bolsa 1 rueda
 Caja de 10 unidades

RUEDA CON FRENO TRANSPARENTE 75 mm

código **180202000**



transparente

bolsa 1 rueda
 Caja de 10 unidades

VENTOSA PARA ESTANTE

código **180203000**



transparente

bolsa 4 ventosas
 Caja de 200 kits

KIT SOPORTE LATERAL PARA BARRA FIJACIÓN FRONTAL DIRECTA

código **180204000**



gris

bolsa 2 soportes
 + fijaciones
 + tornillos
 Caja de 50 kits



SYSKOR
aluminium systems

Foto: Armario vestidor con tiras led de empotrar - Syskor

Iluminación leds para muebles

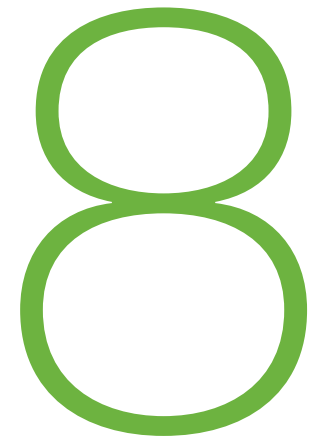

SYSKOR
aluminium systems



Soluciones de **iluminación LED de alta gama y bajo consumo** para roperos, armarios, cocinas y muebles en general.

Cree atmósferas diferentes con nuestro completo programa personalizado de tiras y focos led.

Un sistema de 12 V moderno, seguro, de **fácil instalación y larga duración**.

Encendido automático por presencia para el máximo confort.

Kits de focos y tiras led para muebles

Índice



Kits de tiras led empotrar y superponer
KITS COMPLETOS DE 2 METROS
DE FÁCIL CORTE A MEDIDA
CAJA INTERIOR AUTOVENTA

Kits de focos led de empotrar y/o superponer
KITS COMPLETOS DE 2 Y 3 FOCOS
CAJA INTERIOR AUTOVENTA



Focos - Tiras led - Perfiles aluminio - Difusores

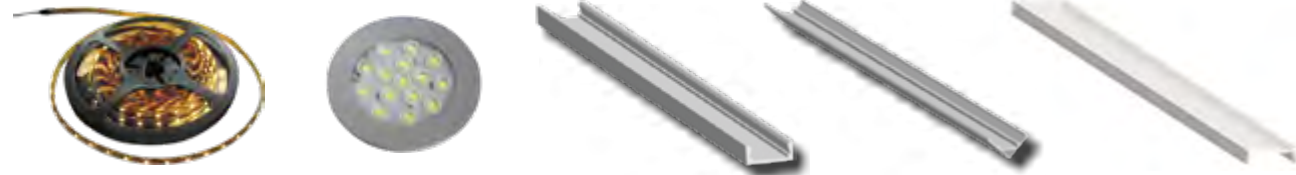

Interruptores / Sensores de contacto, proximidad y movimiento



Transformadores, alargadores, conectores y distribuidores



luxor

program

kits de tiras led

- tiras leds para armario con sensores de apertura
- fácil corte a medida hasta 2 metros

fotografía:
kit tiras led empotradas en Volare V80 Adapta

SYSKOR
kitchen & home fittings

Cod. **LKIT00201**

Kit completo tira de leds empotrados de 2m.

Recomendado para los programas Syskor de puertas correderas colgantes **Inline**, **Volare** y apoyadas **W40**

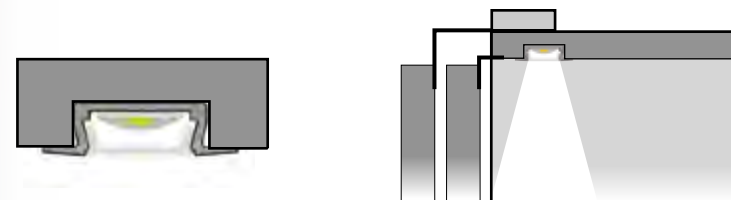

Cod. **LKIT00202**

Kit completo tira de leds de superficie de 2m.

Recomendado para los programas Syskor de puertas correderas apoyadas **Terra** y **Base**

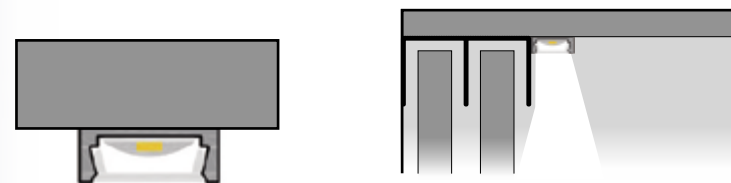

fotografía:
kit tiras led de superficie en Terra

Kits completos luxor de tiras led con 2 sensores de apertura de puerta

Fácil corte a medida hasta 2 metros

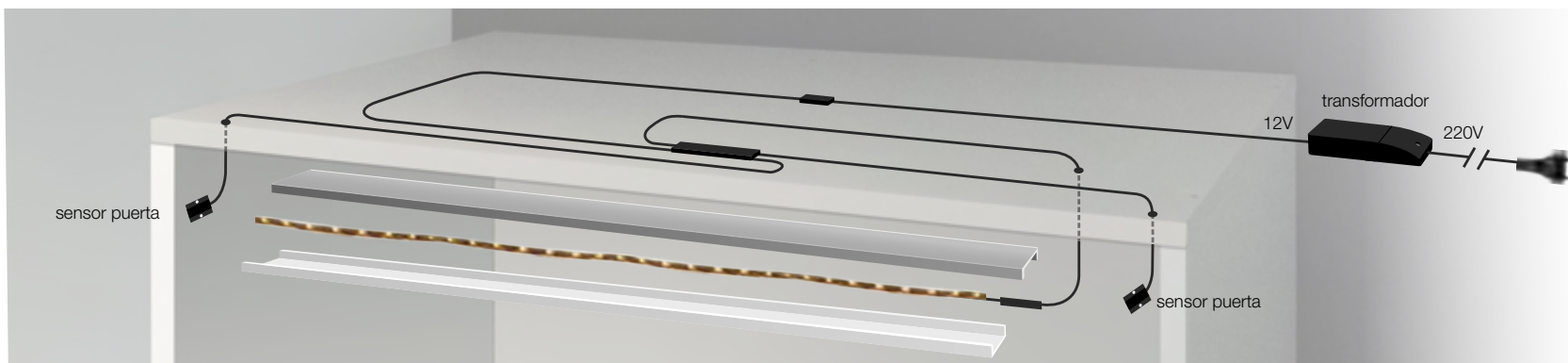

Sensores de apertura de puertas

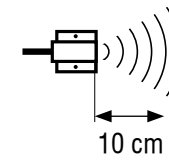

Puerta cerrada: Apagado
Puerta abierta: Encendido

Cod. **LKIT00201**

KIT COMPLETO TIRA DE LEDS EMPOTRADOS DE 2M. CON 2 SENSORES DE APERTURA

Recomendado para los programas Syskor de puertas correderas colgantes **Inline**, **Volare** y apoyadas **W40**

Caja interior autoventa de 1 kit - Embalaje exterior de 4 kits

Kit para un armario compuesto de:

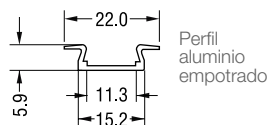

Perfil aluminio empotrado

-  1 difusor blanco de 2 metros
-  1 tira de leds 2 metros, 12V-9,6W luz blanco frío
-  1 perfil aluminio empotrado para leds 2000 x 22mm
-  2 tapas laterales para perfil de empotrar
-  1 interruptor-sensor doble presencia rango de detección 10 cm.
-  1 metro cable IN - 1 metro cable OUT
2 cables sensor de 1,5 metros
-  1 transformador de 15W
input 100/240V - 1,5 metros cable
out 12 V DC / 15W-125A-1,5 metros cable hembra

Cod. **LKIT00202**

KIT COMPLETO TIRA DE LEDS DE SUPERFICIE DE 2M. CON 2 SENSORES DE APERTURA

Recomendado para los programas Syskor de puertas correderas apoyadas **Terra** y **Base**

Caja interior autoventa de 1 kit - Embalaje exterior de 4 kits

Kit para un armario compuesto de:

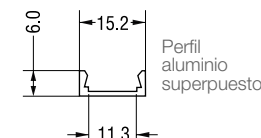

Perfil aluminio superpuesto

-  1 difusor blanco de 2 m
-  1 tira de leds 2 metros, 12V-9,6W luz blanco frío
-  1 perfil aluminio de superficie para leds 2000 x 15mm
-  2 tapas laterales para perfil de superponer
-  4 grapas de montaje y tornillos
-  1 interruptor-sensor doble presencia rango de detección 10 cm.
-  1 metro cable IN - 1 metro cable OUT
2 cables sensor de 1,5 metros
-  1 transformador de 15W
input 100/240V - 1,5 metros cable
out 12 V DC / 15W-125A-1,5 metros cable hembra

luxor

program

kits de focos led

- focos leds para armario con sensores de apertura
- kits de 2 y 3 focos

fotografía:
kits focos led en Volare V80 Adapta

SYSKOR
kitchen & home fittings



Cod. **LKIT00102**

Kit completo 2 focos led de empotrar-superponer

Cod. **LKIT00103**

Kit completo 3 focos led de empotrar-superponer

Recomendado para todos los programas Syskor de puertas correderas colgantes y apoyadas



fotografía:
kit focos led en Terra

Kits completos luxor de focos led con 2 sensores de apertura de puerta

Kits de 2 y 3 focos de empotrar-superponer

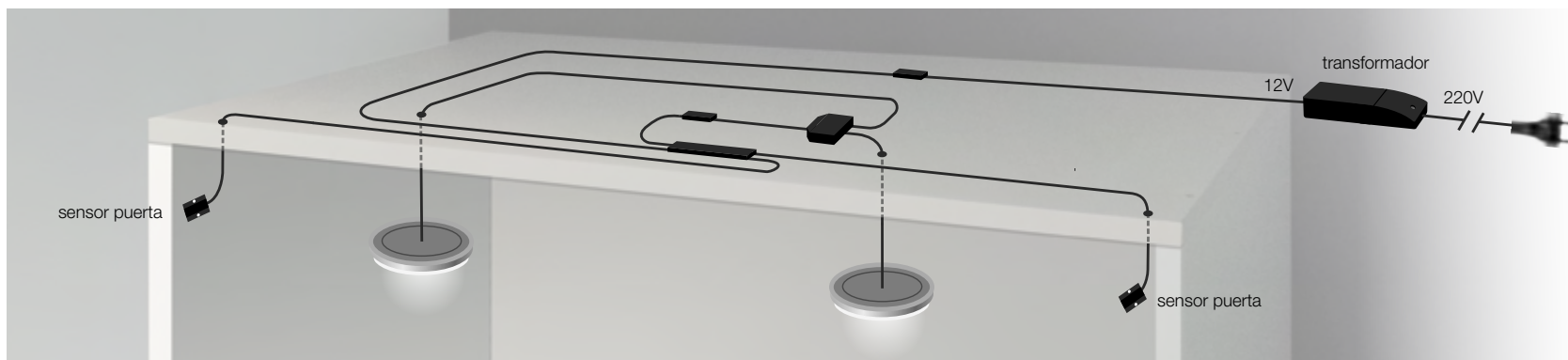

Sensores de apertura de puertas

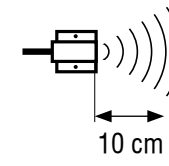

Puerta cerrada: Apagado
Puerta abierta: Encendido

Cod. **LKIT00102**

KIT COMPLETO 2 FOCOS LED EMPOTRAR-SUPERPONER CON 2 SENSORES DE APERTURA

Recomendado para todos los programas Syskor de puertas correderas colgantes y apoyadas

Caja interior autoventa de 1 kit - Embalaje exterior de 4 kits

Kit para un armario compuesto de:



2 focos led Ø70mm con posibilidad de empotrar o superponer 2W con cable macho de 1,5 metros



1 distribuidor de 3 salidas de 1 metro



1 interruptor-sensor doble presencia rango de detección 10 cm.
1 metro cable IN - 1 metro cable OUT
2 cables sensor de 1,5 metros



1 transformador de 6W
input 100/240V - 1,5 metros cable
out 12 V DC / 15W-125A-1,5 metros cable hembra

Cod. **LKIT00103**

KIT COMPLETO 3 FOCOS LED EMPOTRAR-SUPERPONER CON 2 SENSORES DE APERTURA

Recomendado para todos los programas Syskor de puertas correderas colgantes y apoyadas

Caja interior autoventa de 1 kit - Embalaje exterior de 4 kits

Kit para un armario compuesto de:



3 focos led Ø70mm con posibilidad de empotrar o superponer 2W con cable macho de 1,5 metros



1 distribuidor de 3 salidas de 1 metro



1 interruptor-sensor doble presencia rango de detección 10 cm.
1 metro cable IN - 1 metro cable OUT
2 cables sensor de 1,5 metros



1 transformador de 6W
input 100/240V - 1,5 metros cable
out 12 V DC / 15W-125A-1,5 metros cable hembra



FOCO REDONDO DIAMETRO 70 TRANSPARENTE

Cod. L04001121

2W con cable macho de 1,5mts

pc color silver

Posibilidad de empotrar o superponer*

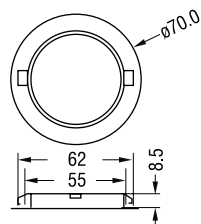

TIRA LEDS 5 MTS - 12V-24W-LUZ BLANCO FRÍO

Cod. L01001120

TIRA LEDS 2 MTS - 12V-9,6W-LUZ BLANCO FRÍO

Cod. L01002120

con cable macho de 20 cms

ancho 8 mm

aluminio plata

**PERFIL Aluminium EMPOTRADO PARA LEDS
2000 x 22 nº1**

Cod. L02001000

caja de 25 tiras

TAPAS LATERALES PARA PERFIL nº 1

Cod. L01021000

pc gris

aluminio plata

**PERFIL Aluminium DE SUPERFICIE PARA LEDS
2000 x 15 nº2**

Cod. L02002000

caja de 25 tiras
25 strips box

TAPAS LATERALES PARA PERFIL nº 2

Cod. L01022000

pc gris

GRAPAS DE MONTAJE PARA PERFIL nº 2

Cod. L01023000

acero inoxidable



DIFUSOR BLANCO DE 2000 mm PARA PERFIL nº1 y nº2

Cod. L01024000

caja de 25 tiras





aluminio plata



PERFIL DE Aluminium EN ANGULO PARA LEDS 90° DE 2000 x 26 mm nº3
Cod. L02003000

caja de 25 tiras
25 strips box



GRAPAS DE MONTAJE PARA PERFIL nº 3
FITTING BRACKETS FOR PROFILE NR3
Cod. L01029000

acero inoxidable



pc blanco

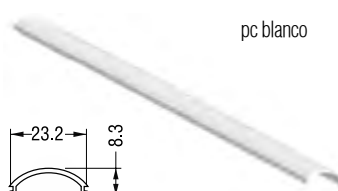

DIFUSOR BLANCO DE 2000 mm CURVO PARA PERFIL nº 3
Cod. L01027000

caja de 25 tiras
25 strips box



TAPAS LATERALES PARA PERFIL Nº 3 CON DIFUSOR CURVO
Cod. L01028000

pc blanco

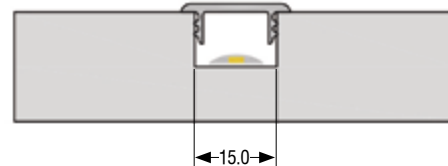
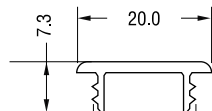

DIFUSOR MULTIUSO BLANCO DE 2000 x 20 mm
Cod. L01030000

caja de 25 tiras



INTERRUPTOR SENSOR PRESENCIA (PROXIMIDAD)

Cod. L01012000

24W

rango de detección 10 cms
1 mt cable in - 1 mt cable out
cable sensor 1,5 mts

Puerta cerrada: Apagado
Puerta abierta: Encendido
Recomendado para puertas de armario



DOBLE INTERRUPTOR SENSOR PRESENCIA (PROXIMIDAD)

Cod. L01015000

24W

rango de detección 10 cms
1 mt cable in - 1 mt cable out
cable sensor 1,5 mts

Puerta cerrada: Apagado
Puerta abierta: Encendido
Recomendado para puertas correderas de armario

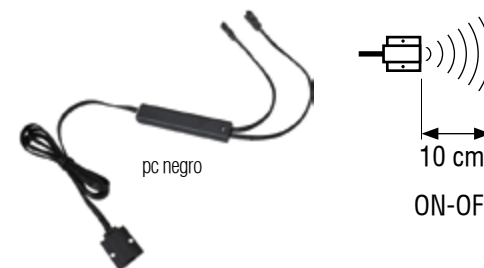

INTERRUPTOR SENSOR ON/OFF POR PROXIMIDAD

Cod. L01013000

24W

rango de detección 10 cms
1 mt cable in - 1 mt cable out
cable sensor 1,5 mts

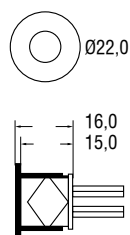

INTERRUPTOR DE CONTACTO CON REGULACIÓN DE INTENSIDAD PARA EMPOTRAR

Cod. L01014000

Un toque: ON-OFF
Manteniendo apretado:
Regulación de intensidad

24-48W
1 mt cable in - 1 mt cable out



INTERRUPTOR SENSOR VOLUMÉTRICO (MOVIMIENTO)

MOTION SENSOR SWITCH

Cod. L01011000

24W

rango de detección 1,5 mts
tiempo de encendido: 40 segundos

1 mt cable in - 1 mt cable out
cable sensor 1,5 mts

40 segundos de encendido



TRANSFORMADOR EXTRAPLANO CON 4 SALIDAS 15W

Cod. L01050000

input 220/240V 1,5 mts cable - interruptor ON/OFF - switch ON/OFF -
OUT 12V DC/15W - 1,25A ON/OFF



**TRANSFORMADOR CON CABLE SALIDA 1,5MTS
TERMINAL HEMBRA**

Cod. L01051000 6 W

Cod. L01052000 15 W

input 100/240V - 1,5 mts cable out 12V DC/15W - 1,25A -
1,5 mts cable hembra / female



**TRANSFORMADOR 30W CON CABLE SALIDA
1,5MTS TERMINAL HEMBRA**

Cod. L01053000

input 100/240V - 1,5 mts cable out 12V DC/30W-1,25A -
1,5 mts cable hembra/female



negro

DISTRIBUIDOR 3 SALIDAS

Cod. L01054000

1 m



negro

ALARGADOR 1 MT MACHO/HEMBRA

Cod. L01058000

1 m



negro

DISTRIBUIDOR 6 SALIDAS

Cod. L01055000

1 m



negro

CABLE 1MT MACHO/GRAPA PARA TIRA LED

Cod. L01059000

1 m

De gran utilidad como **expositores de mostrador o portátiles** por su compacto diseño, se convertirán en una herramienta de presentación indispensable para la promoción de los herrajes para mueble Syskor.

MAQUETA EXPOSITOR FUNCIONAL SISTEMA AXIS FREE PUERTAS PLEGABLES-CORREDERAS

cod. 660AXF000

* Embalaje: 1 unidad

Dimensiones

Alto 300 mm x Largo 600 mm x Ancho 290 mm



MAQUETA EXPOSITOR FUNCIONAL SISTEMA COPLANAR MURANO INLINE

cod. MIL000EXP

* Embalaje: 1 unidad



MAQUETA EXPOSITOR FUNCIONAL SISTEMA VOLARE V80 ADAPTA PUERTAS CORREDERAS COLGANTES

cod. VF0000EXP

* Embalaje: 1 unidad





CAJA EXPOSITOR V35

Expositor de herrajes modelo VOLARE V35

Cod. V35EXP000

* Embalaje: 1 unidad



CAJA EXPOSITOR TERRA TOP LINE

Expositor muestrario TERRA TOP LINE

Cod. 100TTLEXP

* Embalaje: 1 unidad



**CAJA EXPOSITOR AIR M60
PUERTA CORREDERA DE PASO**

Expositor de herrajes modelo M60

Cod. 170EXPM60

* Embalaje: 1 unidad



**CAJA EXPOSITOR LÁMPARAS LED
LUXOR LIGHT BOX**

Expositor de luces LED con sensores de presencia

Cod. L000000000

* Embalaje: 1 unidad

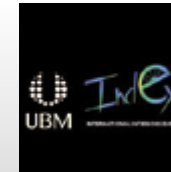
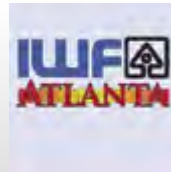

Configurador on-line para puertas correderas

Programa para medidas de corte de perfiles

Simplemente rellene las medidas del hueco de armario, seleccione el programa y modelo de perfil. El configurador automáticamente le calculará todos los cortes de perfil y tablero. Además podrá visualizar el armario en sus diferentes diseños y acabados.



elige el sistema (carril alto)



elige el carril bajo



elige el tirador

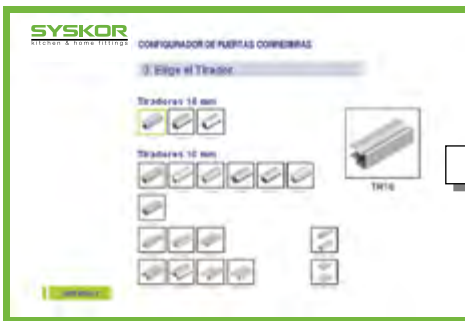

describe tu armario



obtén las dimensiones de corte de perfiles y tableros



diseña tu armario



diseña tu armario

